



13 1/4" ETA G10.212 PRD

CT G10212 FDE 593132 02 07.03.2016



13 1/4" Ø 31,75 mm

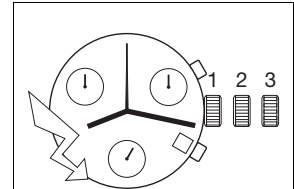

Hauteur sur mouvement	Höhe auf Werk	Movement height	5,12 mm
Hauteur sur pile	Höhe auf Batterie	Height on battery	5,12 mm
Nombre de rubis	Anzahl Rubine	Number of jewels	4
Fréquence	Frequenz	Frequency	32'768 Hz

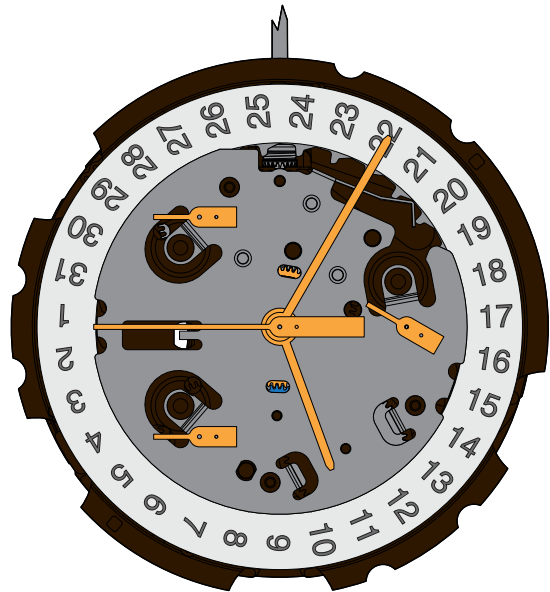
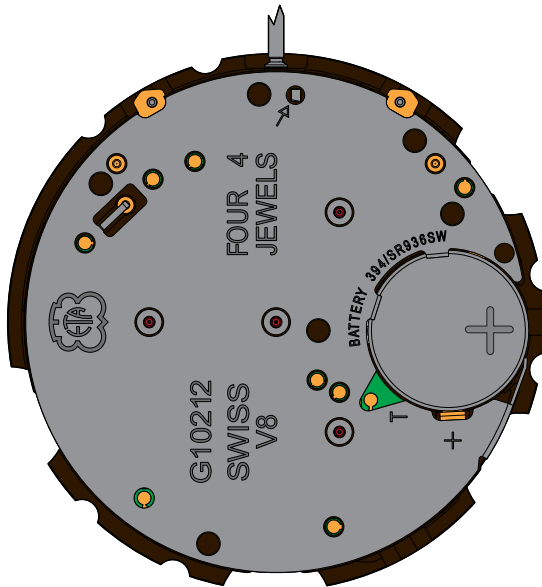

Les travaux de réparation et de révision ne doivent être effectués que par du personnel dûment formé.
Reparatur- und Revisionsarbeiten dürfen nur von ausgebildetem Fachpersonal ausgeführt werden.
The repair and reconditioning work must only be performed by properly trained personnel.



Informations générales



Avant de démarrer les travaux, veuillez svp étudier attentivement cette "*Communication technique*".



La protection des yeux est obligatoire pour toutes les interventions / tous les travaux sur le mouvement!



ETA SA décline toute responsabilité en cas de dommages du non respect de cette "*Communication technique*".

Exigences en matière de protection de l'environnement



Les dispositions légales en matière de traitement et d'élimination des déchets doivent être respectées lors de toutes les interventions / tous les travaux sur les mouvements!

En particulier, les produits de graissage et de nettoyage néfastes pour l'environnement doivent être éliminés selon les règles!



Les **substances de nature à polluer l'eau** doivent être entreposées, transportées, récupérées et éliminées dans des récipients adéquats.

Elles ne doivent en aucun cas polluer le sol ou être évacuées dans les réseaux de canalisation!

Explication des symboles



Attention! Risque de dégât matériel!

Ci-après quelques instructions à suivre obligatoirement pour éviter tout dégât matériel!

Allgemeine Informationen



Diese "*Technische Mitteilung*" ist **vor** dem Beginn der Arbeiten genauestens zu studieren.



Für sämtliche Arbeiten am und mit dem Uhrwerk ist ein Augenschutz obligatorisch!



Für Schäden, welche durch Nichtbeachtung dieser "*Technischen Mitteilung*" entstehen, haftet die ETA SA nicht.

Umweltschutz-Vorschriften



Bei allen Arbeiten am und mit dem Uhrwerk sind die gesetzlichen Vorschriften zur ordnungsgemässen Verwertung und Beseitigung der Abfälle einzuhalten!

Insbesondere sind umweltgefährdende Schmier- und Reinigungsmittel ordnungsgemäss zu entsorgen!



Wassergefährdende Stoffe müssen in geeigneten Behältern aufbewahrt, transportiert, aufgefangen und entsorgt werden.

Diese dürfen nicht den Boden belasten oder in die Kanalisation gelangen!

Symbolerklärung



Achtung! Gefahr von Sachschäden!

Hier folgen wichtige Hinweise, die zur Vermeidung von Sachschäden unbedingt beachtet werden müssen!

General information



Before starting work, please study this "*Technical communication*" carefully.



Eye protection is obligatory for all operations / work on the movement!



ETA SA disclaims any liability in case of damage arising from failure to observe this "*Technical communication*".

Environmental protection requirements



The legal provisions relating to waste handling and disposal must be observed in all operations / work on the movements!

In particular, lubricating and cleaning products harmful to the environment must be disposed of in accordance with the rules!



Substances prone to cause water pollution must be stored, transported, collected and disposed of in appropriate vessels.

Under no circumstances must they pollute the soil or be poured into sewage systems!

Explanation of symbols



Caution! Risk of material damage!

Below are some obligatory instructions for preventing any material damage!

Liste des fournitures - Bestandteilliste - List of components

Pos	No Nr No	No Nr CS No	Numéro d'article Artikelnummer Article number	Liste des fournitures	Bestandteilliste	List of components
1	405	51.020.21	Var	Tige de mise à l'heure	Stellwelle	Handsetting stem
2	4929	20.570.00	7613226082656	Pile	Batterie	Battery
			Var	Variante	Variante	Variant

**L'interchangeabilité et les variantes se trouvent sur
ETA ONLINE SHOP (EOS) :**

www.eta.ch
→ Customer Service
→ Customer Service Portal

**Die Austauschbarkeit und Varianten finden Sie im
ETA ONLINE SHOP (EOS):**

www.eta.ch
→ Customer Service
→ Customer Service Portal

**Interchangeability and variants
can be found on the
ETA ONLINE SHOP (EOS):**

www.eta.ch
→ Customer Service
→ Customer Service Portal

Fournitures - Bestandteile - Materials

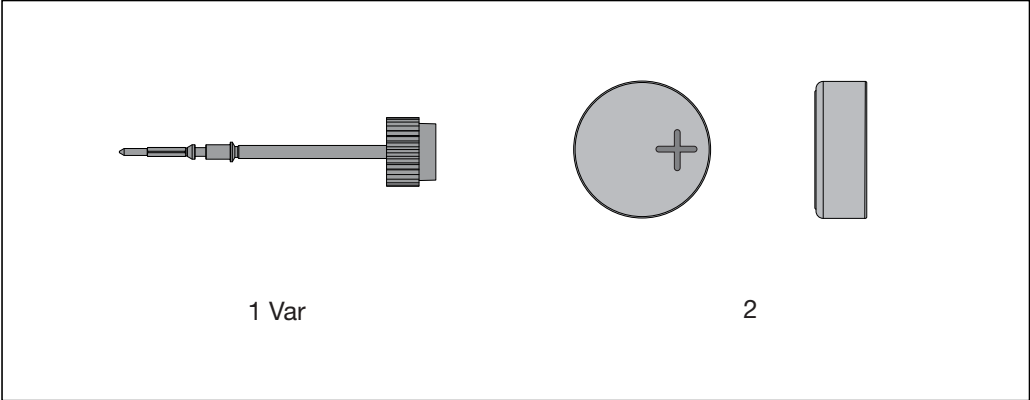



Mouvement indémontable !
Undemontierbares Werk !
Movement undivisible !

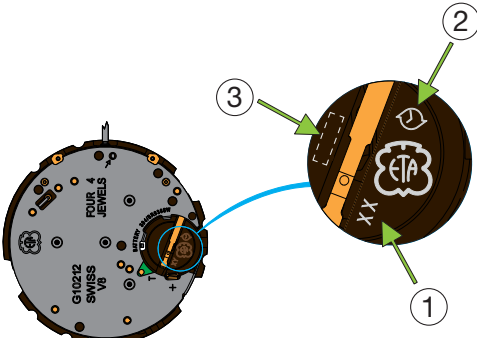

Identification - Kennzeichnung - Identification

	<p>1 Code de fonction (voir "Information Habillage"). Funktionscode (siehe "Fabrikanten Information"). Function code (see "Manufacturing information").</p> <p>2 Logo PRECIDRIVE</p> <p>3 Zone de marquage ETA SA. Zone für Markierungen ETA SA. Zone for marking ETASA.</p>
--	---

Pour les informations concernant le retrait et la pose des aiguilles voir:

Information Habillage
 "RETRAIT DES AIGUILLES"
 "POSE DES AIGUILLES"

Für Informationen für das Entfernen und Setzen der Zeiger siehe:

Fabrikanten Information
 "ZEIGER ENTFERNEN"
 "ZEIGER SETZEN"

For remove hands and hand-fitting details please see:

Manufacturing Information
 "REMOVE HANDS"
 "HAND-FITTING"

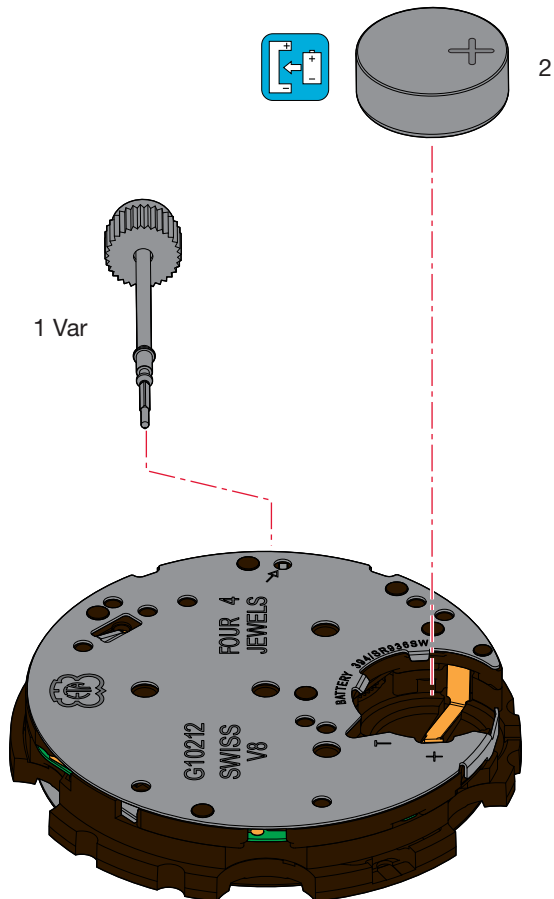

Contrôles électriques - Elektrische Kontrollen - Electrical Tests

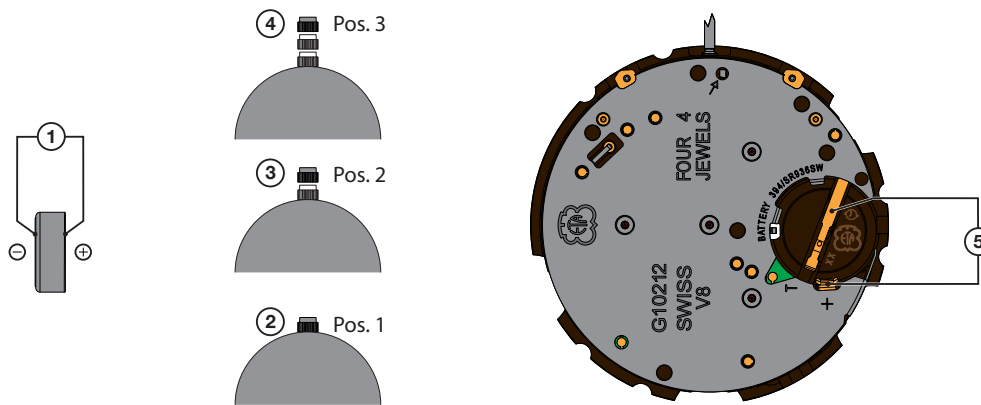

Mesure	Position	Méthode et limite	Echelle de mesure	Remarques
Tension de la pile	①	Tension de la pile $U > 1,50 \text{ V}$	2 V ($R_i \geq 10 \text{ k}\Omega$)	Contrôler la tension de la pile hors du mouvement.
Fonctionnement des moteurs	②	Poser la pile avec la tige en position 1 exclusivement et observer que les moteurs des compteurs réalisent un tour lent et régulier.	10 μA	Mesure avec une pile contrôlée. Si la pile est déchargée, le mouvement reste à l'arrêt.
	③	Tirer la tige en position 2 et observer que les moteurs des compteurs réalisent un tour rapide et régulier.		
Consommation du module électronique	④ + ⑤	Tige en position 3 $I \leq 0,70 \mu\text{A}$	10 μA	Mesure sans pile avec alimentation extérieure de 1,55 V.
Consommation du mouvement	② + ⑤	Tige en position 1 + remise à zéro du chronographe. $I \leq 4,00 \mu\text{A}$		
Consommation du mouvement et du chronographe	② + ⑤	Tige en position 1 + START du chronographe, mesure après le mouvement continu rapide d'une aiguille. $I \leq 8,00 \mu\text{A}$		

• Ohmmètres avec tension de mesure supérieur à 0,40 V inappropriés, tension recommandée = 0,20 V.

Les contrôles doivent être effectués à une température ambiante entre 20° C et 25° C.

Messung	Messpunkt	Verfahren und Grenzwerte	Einstellung Messgerät	Bemerkungen
Spannung der Batterie	①	Spannung der Batterie $U > 1,50 \text{ V}$	2 V ($R_i \geq 10 \text{ k}\Omega/V$)	Kontrolle der Betriebsspannung ausserhalb des Uhrwerks.
Funktionsweise der Motoren	②	Batterie mit der Stellwelle ausschliesslich in Position 1 platzieren und darauf achten, dass die Motoren der Zähler eine langsame und regelmässige Umdrehung machen.	10 μA	Messung mit kontrollierter Batterie. Wenn die Batterie entladen ist, bleibt das Uhrwerk stehen..
	③	Stellwelle auf Position 2 ziehen und darauf achten, dass die Motoren der Zähler eine schnelle und regelmässige Umdrehung machen..		
Stromaufnahme Elektronik-Baugruppe	④ + ⑤	Stellwelle in Position 3 $I \leq 0,70 \mu\text{A}$	10 μA	Messung ohne Batterie mit Speisung von aussen, Spannung 1,55 V.
Stromaufnahme Uhrwerk	② + ⑤	Stellwelle in Position 1 + Chronograph auf Null zurückstellen. $I \leq 4,00 \mu\text{A}$		
Stromaufnahme Uhrwerk und Chronograph	② + ⑤	Stellwelle in Position 1 + START Chronograph, Messung beginnen, sobald sich ein Uhrzeiger schnell und regelmässig bewegt. $I \leq 8,00 \mu\text{A}$		

• Ohmmeter mit Prüfspannung über 0,40 V ungeeignet, empfohlene Spannung = 0,20 V.

Die Kontrollen sind bei einer Umgebungstemperatur zwischen 20° C und 25° C durchzuführen.

Measurement	Position	Method and limits	Setting of apparatus	Remarks
Battery voltage	①	Battery voltage $U > 1,50 \text{ V}$	2 V ($R_i \geq 10 \text{ k}\Omega/\text{V}$)	Check the battery voltage outside of the movement.
Motor functioning	②	Place the battery with the stem in position 1 only and make sure that the counter motors perform a slow, even run.		Measurement with controlled battery. If the battery is depleted, the movement will not move.
	③	Move the stem into position 2 and make sure that the counter motors perform a fast, even turn.		
Consumption of electronic module	④ + ⑤	Stem in position 3 $I \leq 0,70 \mu\text{A}$	10 μA	Measurement without battery with external power supply 1.55 V.
Consumption of movement	② + ⑤	Stem in position 1 + reset the chronograph to zero. $I \leq 4,00 \mu\text{A}$		
Consumption of movement and chronograph	② + ⑤	Stem in position 1 + start the chronograph, measurement should only begin once quick and continuous motion of a hand has set in. $I \leq 8,00 \mu\text{A}$		
<ul style="list-style-type: none"> • Ohmmeter with a test voltage higher than 0.40 V unsuitable, recommended voltage = 0.20 V. 				

The tests must be conducted at an ambient temperature between 20° C and 25° C.

Contrôle de la marche instantanée

Pour des informations concernant la contrôle de la marche instantanée voir:

Information Habillage:

- Contrôle de la marche

Kontrolle des momentanen Ganges

Für Informationen betreffend der Kontrolle des momentanen Ganges siehe:

Fabrikanten Information:

- Gangkontrolle

Checking the intantaneous rate

For information regarding checking the instantaneous rate see:

Manufacturing Information

- Checking the rate

Alimentation

Pile à l'oxyde d'argent
 $U = 1,55 \text{ V}$, type "Low drain".

Pile Ø 9,50 mm, hauteur 3,60 mm

Capacité 84 mAh (Renata)

Renata, Varta, Energizer
No 394, SR 936 SW.

Stromversorgung

Silberoxyd-Batterie
 $U = 1,55 \text{ V}$, Typ "Low Drain".

Batterie Ø 9,50 mm, Höhe 3,60 mm

Kapazität 84 mAh (Renata)

Renata, Varta, Energizer
Nr. 394, SR 936 SW.

Current supply

Silver oxide battery
 $U = 1.55 \text{ V}$, "Low Drain" type.

Battery Ø 9.50 mm, height 3.60 mm

Capacity 84 mAh (Renata)

Renata, Varta, Energizer
No. 394, SR 936 SW.

Pose de la pile

Glisser la pile sous les deux languettes métalliques ① du couvre-module.

Presser la pile au fond de son logement ②. Le doigt du couvre-module ③ maintient la pile en place.

L'outil ne doit pas être conducteur d'électricité!

Batterie einsetzen

Schieben Sie die Batterie unter die beiden Metallaschen ① der Modulabdeckung.

Drücken Sie die Batterie fest in die Halterung ②. Der Finger der Modulabdeckung ③ fixiert die Batterie in der Halterung.

Das Werkzeug darf nicht elektrisch leitend sein!

Fitting the battery

Slide the battery under the two metal ① tabs of the module cover.

Press the battery firmly into its mounting ②. The finger of the module cover ③ keeps the battery in position.

The tool must not be electrically conductive!

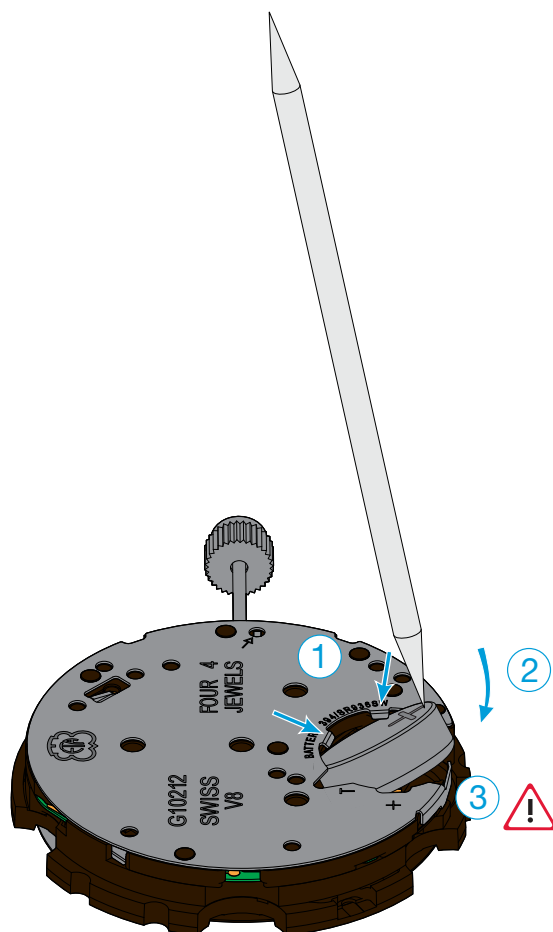

Retrait de la pile

Glisser un outil ① entre le doigt de maintien et la pile (voir dessin) et faire levier sous celle-ci en écartant très légèrement ② le doigt du couvre-module vers l'arrière ③ . Sortir la pile.

L'outil ne doit pas être conducteur d'électricité!

Batterie herausnehmen

Führen Sie ein Werkzeug ① zwischen Haltefinger und Batterie ein (siehe Abbildung). Heben Sie die Batterie mit leichtem Druck nach hinten ② auf den Finger der Modulabdeckung ③ . Nehmen Sie die Batterie heraus.

Das Werkzeug darf nicht elektrisch leitend sein!

Removing the battery

Insert tool ① between maintaining finger and battery (see drawing) and try out the battery by gently lifting back ② the module cover catch ③ . Remove the battery.

The tool must not be electrically conductive!

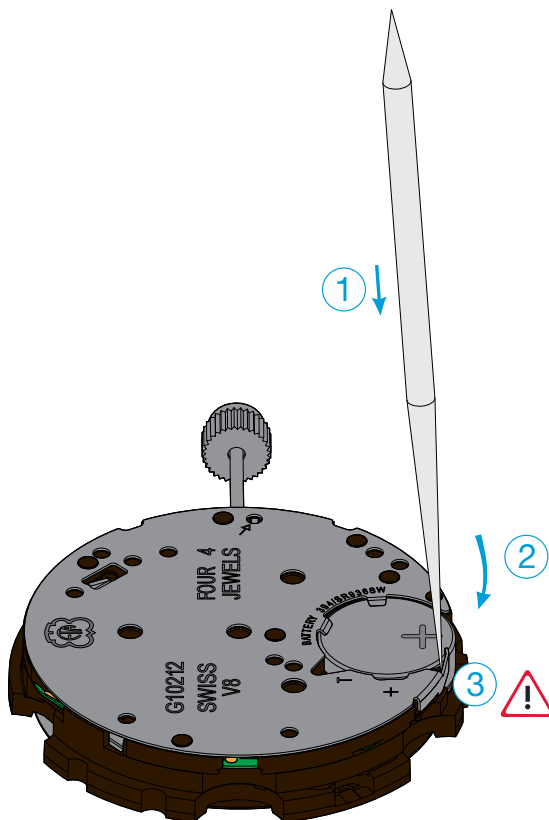

Attention!

Au moment d'insérer/de retirer la pile, impérativement veiller à ne pas déformer ni distendre la bride de fixation de pile! (espace restreint).



Achtung!

Beim Einsetzen/Herausnehmen der Batterie unbedingt darauf achten, dass die Batteriehalterfeder nicht deformiert oder überdehnt wird! (enge Platzverhältnisse).



Caution!

When inserting or removing the battery, it is vital to ensure that the battery clamp is not deformed or overstretched (given the tight space).

Extraction de la tige de mise à l'heure

Positionner obligatoirement la tige de mise à l'heure en position 2 (position intermédiaire) avant de presser sur le point à droite de la tirette.

Entfernen der Stellwelle

Erst die Stellwelle in Position 2 (Zwischenposition) drücken, dann zum Lösen der Stellwelle auf den Punkt rechts auf den Winkelhebel drücken.

Extracting the stem

The handsetting stem must be pushed back to position 2 (intermediate position) before pressing on the point lying on the right sider of the lever.

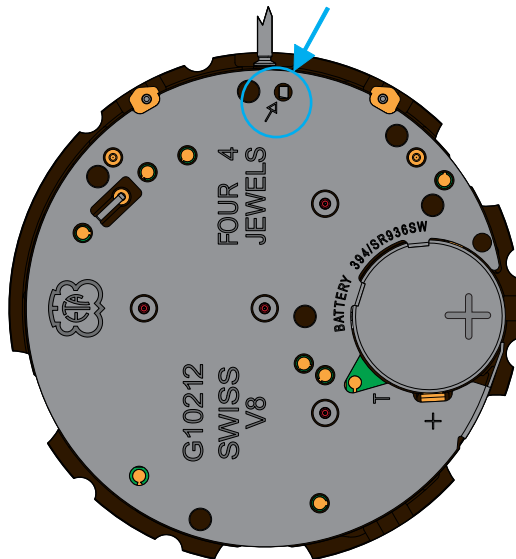

Initialisation des aiguilles du chronographe

Après un changement de pile, ou exceptionnellement en cas de dérangement, il est nécessaire d'initialiser les aiguilles du chronographe à zéro (origine).

Pour des informations concernant initialisation des aiguilles du chronographe voir:

Mode d'emploi:

- Mise à zéro des compteurs

Grundeinstellung der Chronozeiger

Nach einem Batteriewechsel, oder ausnahmsweise im Falle einer Störung, ist es erforderlich, die Chrono-Zeiger auf Null (Anfangszeit) einzustellen.

Für Informationen betreffend der Grundeinstellung der Chronozeiger siehe:

Gebrauchsanweisung:

- Nullstellung der Zähler

Setting the chronograph hands

After a battery change, or exceptionally in case of disturbance, it is necessary to set the chronograph hands to zero (original time).

For information regarding setting chronograph hands see:

Directions for use

- Setting the counters to zero



Pour des informations concernant les aiguillages voir:

Information Habillage

Plan:
AIGUILLAGES
ZEIGERWERKHÖHEN
HAND FITTING HEIGHTS



Für Informationen betreffend der Zeigerwerkhöhen siehe:

Fabrikanten Information

Zeichnung:
AIGUILLAGES
ZEIGERWERKHÖHEN
HAND FITTING HEIGHTS



For information regarding hand fitting heights see:

Manufacturing Information

Drawing:
AIGUILLAGES
ZEIGERWERKHÖHEN
HAND FITTING HEIGHTS

**Modifications comparées aux versions
précédentes du document**

**Änderungen gegenüber vorher-
gehenden Dokumentversionen**

**Modifications compared with previous
document versions**

Version	Date Datum Date	Modification	Änderung	Modification	Page Seite Page
02	07.03.2016	Ajout texte	Ergänzung Text	Addition text	5
01	04.03.2015	Adaptation	Anpassung	Adaptation	7
00	28.01.2015	Version de base	Basis Version	Basic version	--

Sous réserve de toutes modifications.

Änderungen vorbehalten.

All modifications reserved.

**Ce document se trouve sur le
Customer Service Portal (CSP) :**

www.eta.ch

- Customer Service
- Customer Service Portal
- Documents techniques

**Dieses Dokument finden Sie im
Customer Service Portal (CSP):**

www.eta.ch

- Customer Service
- Customer Service Portal
- Technische Dokumente

**This document can be found on the
Customer Service Portal (CSP):**

www.eta.ch

- Customer Service
- Customer Service Portal
- Technical Documents



ETA^{SA}
MANUFACTURE HORLOGÈRE SUISSE
DEPUIS 1793

SC MARKETING & COMMUNICATION

Bahnhofstrasse 9
2540 Grenchen
Switzerland

Phone +41 (0)32 655 71 11
Fax +41 (0)32 655 71 74

contact@eta.ch
www.eta.ch



13 1/4" ETA G10.212 PRD

CT G10212 ESI 593140 02 07.03.2016



13 1/4" Ø 31,75 mm

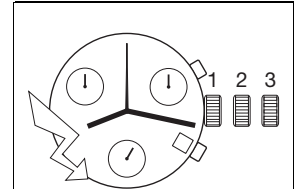

Movement height	Altura sobre máquina	Altezza sopra movimento	5,12 mm
Height on battery	Altura sobre pila	Altezza sopra pila	5,12 mm
Number of jewels	Número de piedras	Numero di pietre	4
Frequency	Frecuencia	Frequenza	32'768 Hz

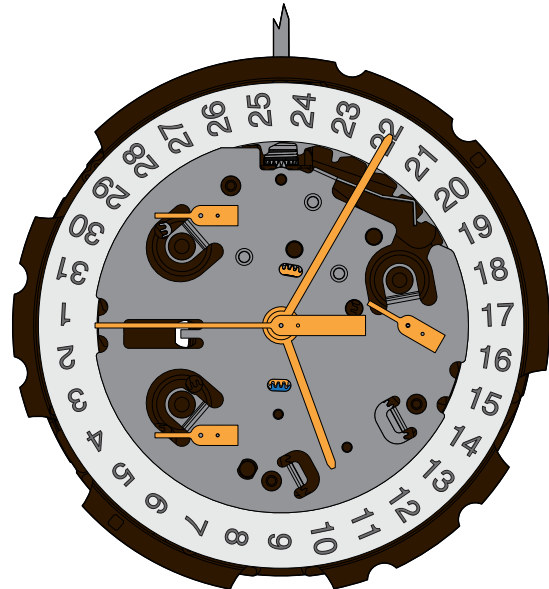
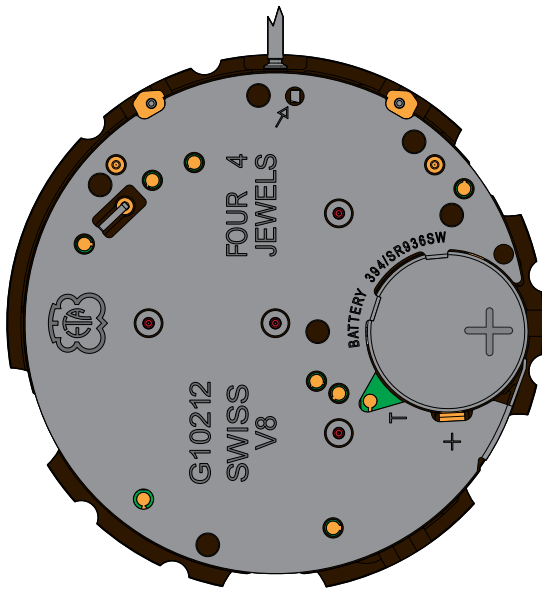

The repair and reconditioning work must only be performed by properly trained personnel.
Las tareas de reparación y revisión sólo deben ser llevadas a cabo por personal debidamente formado.
I lavori di riparazione e di revisione devono essere eseguiti esclusivamente da personale adeguatamente formato.

General information



Before starting work, please study this "Technical communication" carefully.



Eye protection is obligatory for all operations / work on the movement!



ETA SA disclaims any liability in case of damage arising from failure to observe this "Technical communication".

Environmental protection requirements



The legal provisions relating to waste handling and disposal must be observed in all operations / work on the movements!

In particular, lubricating and cleaning products harmful to the environment must be disposed of in accordance with the rules!



Substances prone to cause water pollution must be stored, transported, collected and disposed of in appropriate vessels.

Under no circumstances must they pollute the soil or be poured into sewage systems!

Explanation of symbols



Caution! Risk of material damage!

Below are some obligatory instructions for preventing any material damage!

Información general



Esta "Comunicación técnica" deberá estudiarse muy bien **antes** de comenzar los trabajos.



Es obligatorio utilizar protección ocular para todos los trabajos en y con el reloj.



ETA SA no se hace responsable de los daños provocados como consecuencia de la inobservancia de esta "Comunicación técnica".

Normas de protección medioambiental



Deberá cumplirse la normativa legal relativa al reciclaje y la eliminación correctos de los residuos en todos los trabajos en y con el reloj.

En especial, deberán eliminarse correctamente los productos lubricantes y de limpieza peligrosos para el medio ambiente.



Las sustancias contaminantes del agua deben recogerse, almacenarse, transportarse y eliminarse en recipientes adecuados.

En ningún caso se permitirá que contaminen el suelo o que lleguen a la canalización.

Significado de los símbolos



Atención Peligro de daños materiales

Instrucciones que deberán respetarse necesariamente para evitar daños materiales.

Informazioni generali



Questa "Comunicazione Tecnica" deve essere studiata attentamente **prima** dell'inizio dei lavori.



Per tutti i lavori su e con il movimento dell'orologio è obbligatorio proteggere gli occhi!



ETA SA declina qualunque responsabilità per eventuali danni causati dalla mancata osservanza della presente "Comunicazione tecnica".

Disposizioni relative alla protezione ambientale



Per tutti i lavori su e con il movimento dell'orologio si dovranno rispettare le disposizioni di legge relative al corretto riciclaggio e smaltimento dei rifiuti!

In particolare si dovrà provvedere al corretto smaltimento di lubrificanti e detergenti nocivi per l'ambiente!



Le sostanze inquinanti per l'acqua devono essere conservate, trasportate, raccolte e smaltite in contenitori adatti.

Queste non devono inquinare il terreno o arrivare nelle canalizzazioni!

Spiegazione dei simboli



Attenzione! Pericolo di danni materiali!

Seguono importanti indicazioni che devono essere tassativamente rispettate per evitare danni materiali!

List of components - Lista de piezas - Lista fornitori

Pos	Article number Número de artículo Numero articolo	List of components	Lista de piezas	Lista fornitori
1	Var	Handsetting stem	Tija de puesta en hora	Albero di messa all'ora
2	7613226082656	Battery	Pila	Pila
	Var	Variant	Variante	Variante

**Interchangeability and variants
can be found on the
ETA ONLINE SHOP (EOS):**

www.eta.ch
→ Customer Service
→ Customer Service Portal

**La intercambiabilidad y las
variantes se encuentran en
ETA ONLINE SHOP (EOS):**

www.eta.ch
→ Customer Service
→ Customer Service Portal

**L'intercambiabilità e le varianti si
trovano sul
ETA ONLINE SHOP (EOS):**

www.eta.ch
→ Customer Service
→ Customer Service Portal

Materials - Fornituras - Forniture

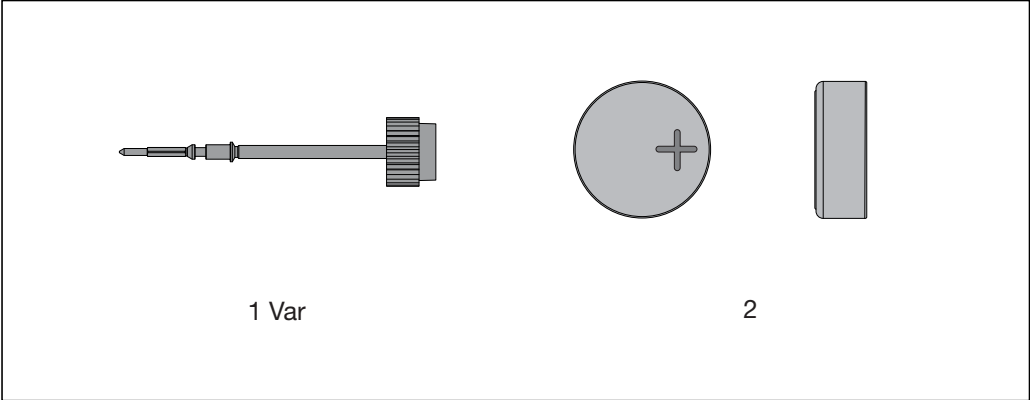

Movement undivisible !
Movimiento no desmontable
Movimento non smontabile !

Identification - Identificación - Identificazione

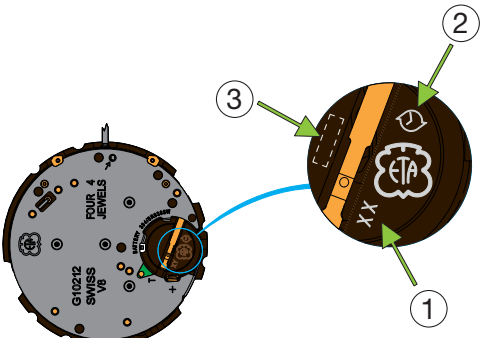
	<p>1 Function code (see "Manufacturing information"). Código función (véase "información de producción"). Codice funzione (vedere "informazione di produzione").</p> <p>2 Logo PRECIDRIVE</p> <p>3 Zone de marquage ETA SA. Zona para marcadoras ETA SA. Zona per marcatura ETASA.</p>
---	---

For remove hands and hand-fitting details please see:

Manufacturing Information
"REMOVE HANDS"
"HAND-FITTING"

Para más información sobre la retirada y ajuste de las agujas, véase:

Información del fabricante
"RETIRAR AGUJAS"
"AJUSTAR AGUJAS"

Per informazioni concernenti la rimozione e la posa delle lancette vedi:

Informazioni del produttore
"RIMOZIONE DELLE LANCETTE"
"POSA DELLE LANCETTE"

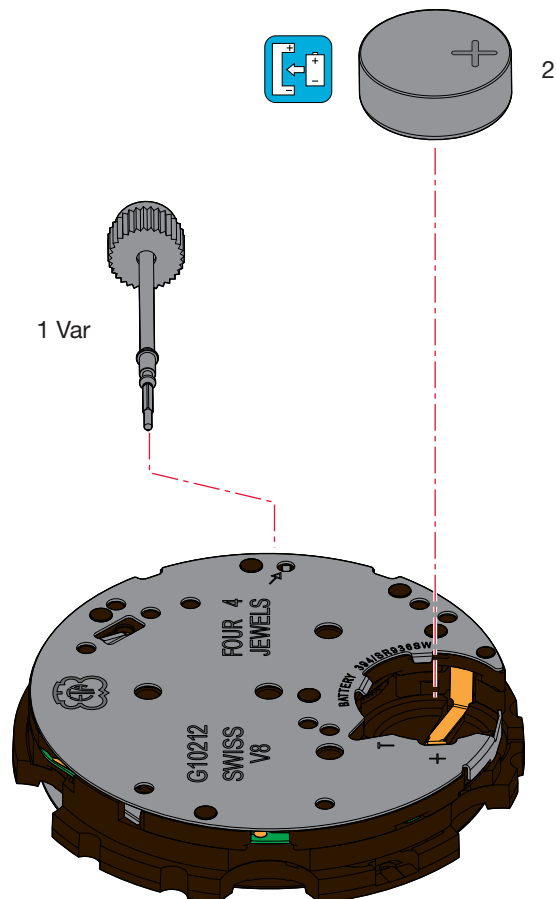

Electrical tests - Controles eléctricos - Controlli elettrici

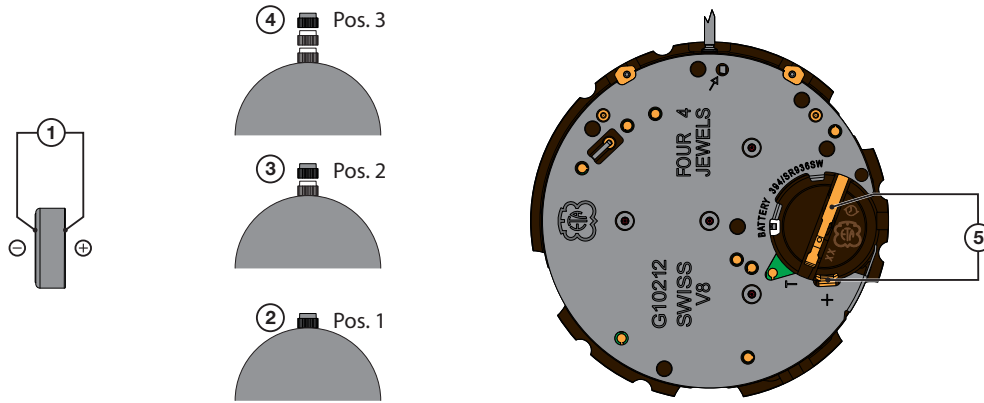

Measurement	Position	Method and limits	Setting of apparatus	Remarks
Battery voltage	①	Battery voltage $U > 1,50 \text{ V}$	2 V ($R_i \geq 10 \text{ k}\Omega/\text{V}$)	Check the battery voltage outside of the movement.
Motor functioning	②	Place the battery with the stem in position 1 only and make sure that the counter motors perform a slow, even run.	10 μA	Measurement with controlled battery. If the battery is depleted, the movement will not move.
	③	Move the stem into position 2 and make sure that the counter motors perform a fast, even turn.		
Consumption of electronic module	④ + ⑤	Stem in position 3 $I \leq 0,70 \mu\text{A}$	10 μA	Measurement without battery with external power supply 1.55 V.
Consumption of movement	② + ⑤	Stem in position 1 + reset the chronograph to zero. $I \leq 4,00 \mu\text{A}$		
Consumption of movement and chronograph	② + ⑤	Stem in position 1 + start the chronograph, measurement should only begin once quick and continuous motion of a hand has set in. $I \leq 8,00 \mu\text{A}$		

• Ohmmeter with a test voltage higher than 0.40 V unsuitable, recommended voltage = 0.20 V.

The tests must be conducted at an ambient temperature between 20° C and 25° C.

Medición	Posición	Método y límite	Escala de medición	Notas
Tensión de la pila	①	Tensión de la pila $U > 1,50 \text{ V}$	2 V ($R_i \geq 10 \text{ k}\Omega/\text{V}$)	Comprobar la tensión de la pila fuera del movimiento.
Funcionamiento de los motores	②	Colocar la pila con la tija en la posición 1 exclusivamente y asegurarse de que los motores de los contadores efectúan una vuelta lenta y regular.	10 μA	Medición con batería controlada. Si la pila está descargada, el movimiento se queda parado.
	③	Arrastrar la tija a la posición 2 y asegurarse de que los motores de los contadores efectúan una vuelta rápida y regular.		
Consumo de módulo eléctrico	④ + ⑤	Tija a la posición 3 $I \leq 0,70 \mu\text{A}$	10 μA	Medición sin pila, con alimentación exterior. 1,55 V.
Consumo de los movimiento	② + ⑤	Tija a la posición 1 + puesta a cero del cronógrafo $I \leq 4,00 \mu\text{A}$		
Consumo de movimiento y cronógrafo	② + ⑤	Tija a la posición 1 + inicio cronógrafo, medida después del movimiento continuo de una aguja. $I \leq 8,00 \mu\text{A}$		

• Ohmímetro on una tensión de prueba superior a 0,40 V inadecuado, tensión recomendada = 0,20 V.

Los controles deben realizarse a una temperatura ambiente comprendida entre 20°C y 25°C.

Misura	Posizione	Metodo e limite	Scala di misura	Osservazioni
Tensione della pila	①	Tensione della pila $U > 1,50 \text{ V}$	2 V ($R_i \geq 10 \text{ k}\Omega/\text{V}$)	Controllare la tensione della pila al di fuori del movimento.
Motor functioning	②	Mettere la pila con l'albero esclusivamente in posizione 1 e prestare attenzione che i motori dei contatori compiano un giro lento e regolare.		Misurazione con batteria controllata. Se la pila è scarica, il movimento si arresta.
	③	Tirare l'albero in posizione 2 e prestare attenzione che i motori dei contatori compiano un giro rapido e regolare.		
Consumo del modulo elettrico	④ + ⑤	L'albero in posizione 3 $\leq 0,70 \mu\text{A}$	10 μA	Misura senza pila, con alimentazione esterna 1,55 V.
Consumo del movimento	② + ⑤	L'albero in posizione 1 + azzerare il cronografo. $\leq 4,00 \mu\text{A}$		
Consumo del movimento e cronografo	② + ⑤	L'albero in posizione 1 + start del cronografo, misurazione non appena una lancetta si muove rapidamente e continuamente. $\leq 8,00 \mu\text{A}$		
<ul style="list-style-type: none"> • Ohmmetro su una tensione di prova superiore a 0,40 V inadatto, tensione consigliata = 0,20 V. 				

I controlli devono essere effettuati a temperatura ambiente compresa tra 20° C e 25° C.

Checking the instantaneous rate

For information regarding checking the instantaneous rate see:

Manufacturing Information:

- Checking the rate

Control de la marcha instantánea

Para información sobre el control de la marcha instantánea véase:

Información productor:

- Control de la march

Controllo della marcia istantanea

Per informazioni riguardo il controllo della marcia istantanea vedere:

Informazioni produttori:

- Controllo della marcia

Current supply

Silver oxide battery
 $U = 1.55 \text{ V}$, "Low Drain" type.

Battery Ø 9.50 mm, height 3.60 mm

Capacity 84 mAh (Renata)

Renata, Varta, Energizer
No. 394, SR 936 SW.

Alimentación

Pila al óxido de plata.
 $U = 1,55 \text{ V}$, tipo "Low Drain".

Pila Ø 9,50 mm, altitud 3,60 mm

Capacidad 84 mAh (Renata).

Renata, Varta, Energizer
No. 394, SR 936 SW.

Alimentazione

Pila all'ossido d'argento
 $U = 1,55 \text{ V}$, tipo "Low Drain" tipo.

Pila Ø 9,50 mm, altezza 3,60 mm

Capacità 84 mAh (Renata).

Renata, Varta, Energizer
No. 394, SR 936 SW.

Fitting the battery

Slide the battery under the two metal ① tabs of the module cover.

Press the battery firmly into its mounting ②. The finger of the module cover ③ keeps the battery in position.

The tool must not be electrically conductive!

Colocación de la pila

Colocar la pila debajo de las dos lengüetas metálicas ① del cubre-módulo.

Apretar la pila al fondo de su alojamiento ②. El dedo del cubre-módulo ③ sujeta la pila en su sitio.

La herramienta no deben ser conductoras de la electricidad!

Posa della pila

Far scivolare la pila sotto le due linguette metalliche ① del copri-modulo.

Premere la pila al fondo del suo alloggiamento ②. Il dito del copri-modulo ③ mantiene la pila nella sua posizione.

L'utensile non deve condurre elettricità!

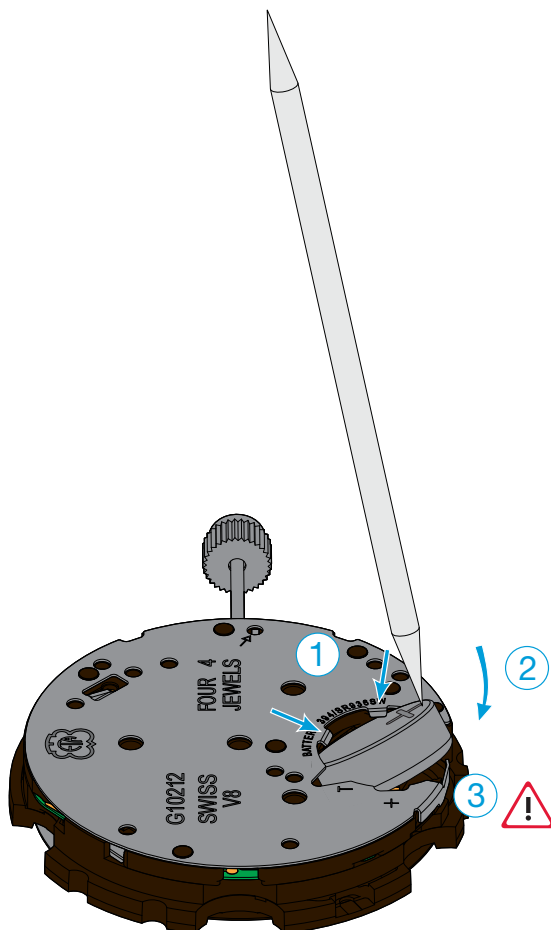

Removing the battery

Insert tool ① between maintaining finger and battery (see drawing) and try out the battery be gently lifting back ② the module cover catch ③. Remove the battery.

The tool must not be electrically conductive!

Retiro de la pila

Conecte con la herramienta ① entre el dedo de mantenimiento y la pila (veáse dibujo) y palanquear la pila apartando cuidadosamente ② el dedo del cubre-módulo ③. Sacar la pila.

La herramienta no deben ser conductoras de la electricidad!

Ritiro della pila

Far scivolare una pinzetta ① tra il dito di sostegno e la pila (si veda disegno) e fare leva sotto quest'ultima allargando leggermente ② il dito di sostegno verso dietro ③. Ritirare la pila.

L'utensile non deve condurre elettricità!

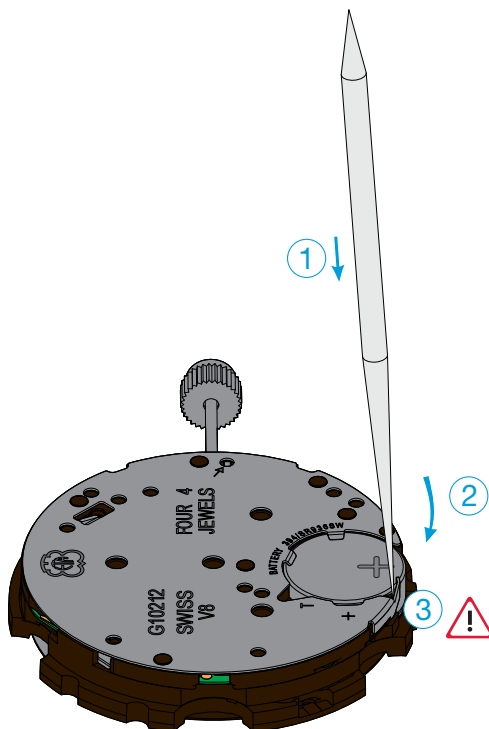

Caution!

When inserting or removing the battery, it is vital to ensure that the battery clamp is not deformed or overstretched (given the tight space).



Atención!

Al poner o sacar la pila es necesario asegurarse de que la brida de fijación de la pila ni esté deformada ni demasiado estirada (condiciones de poco espacio).



Attenzione!

Quando si introduce/estrae la pila fare molto attenzione a non deformare o tendere eccessivamente la brida di fissaggio della pila! (spazi limitati).

Extracting the stem

The handsetting stem must be pushed back to position 2 (intermediate position) before pressing on the point lying on the right sider of the setting lever.

Extracción de la tija de puesta en hora

Antes de pulsar el punto a la derecha del tirete, es obligatorio empujar la tija de puesta en hora en posición 2 (posición intermedia).

Estrazione dell'albero di messa all'ora

Prima di premere il punto a destra del tireto, è obbligatorio premere l'albero di messa all'ora in posizione 2 (posizione intermedia).

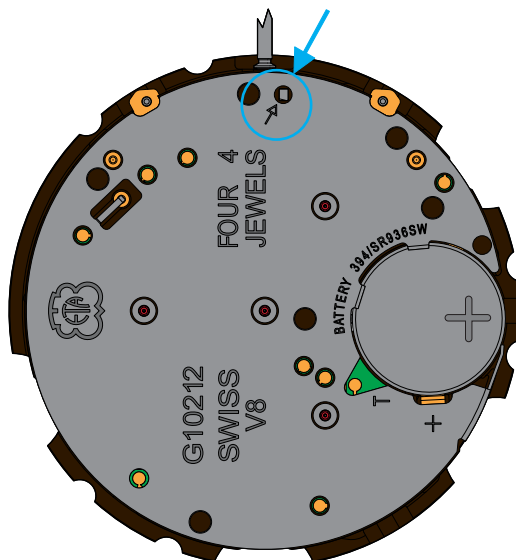

Setting the chronograph hands

After a battery change, or exceptionally in case of disturbance, it is necessary to set the chronograph hands to zero (original time).

For information regarding setting chronograph hands see:

Directions for use:

- Setting the counters to zero

Ajuste de base agujas cronógrafo

Después de un cambio de pila, excepcionalmente en caso de fallo, será necesario poner a cero (hora original) las agujas del cronógrafo.

Para obtener información sobre el inicialización de la vista cronógrafo:

Instrucciones:

- Restablecimiento de los contadores

Impostazione di base lancette crono

In seguito alla sostituzione della batteria o eccezionalmente in caso di guasto, è necessario regolare le lancette del cronografo in posizione zero (ora originale).

Per informazioni sull'inizializzazione vista cronografo veder:

Istruzione:

- Azzeramento dei contatori



For information regarding hand fitting heights see:

Manufacturing Information

Drawing:
AIGUILLAGES
ZEIGERWERKHÖHEN
HAND FITTING HEIGHTS



Para obtener información sobre las alturas de la minutería, consulte:

Información de la producción

Plan:
AIGUILLAGES
ZEIGERWERKHÖHEN
HAND FITTING HEIGHTS



Per informazioni concernenti l'aggiustamento lancette, consultare:

Informazione di produzione

Disegno:
AIGUILLAGES
ZEIGERWERKHÖHEN
HAND FITTING HEIGHTS

Modifications compared with previous document versions**Modificaciones comparadas con las versiones anteriores del documento****Modifiche comparate con le versioni precedenti del documento**

Version Versión Versione	Date Fecha Data	Modification	Modificación	Modifica	Page Página Pagina
01	07.03.2016	Addition text	Agregar texto	Aggiunta testo	5
00	04.03.2015	Basic version	Versión de base	Versione di base	--

All modifications reserved.

Salvo modificación.

Con riserva di ogni eventuale modifica.

This document can be found on the
Customer Service Portal (CSP):

www.eta.ch

- Customer Service
- Customer Service Portal
- Technical Documents

Este documento se encuentran en el
Customer Service Portal (CSP):

www.eta.ch

- Customer Service
- Customer Service Portal
- Technical Documents

Il presente documento si trovano sul
Customer Service Portal (CSP):

www.eta.ch

- Customer Service
- Customer Service Portal
- Technical Documents



ETA^{SA}
MANUFACTURE HORLOGÈRE SUISSE
DEP. N. 5.1793

SC MARKETING & COMMUNICATION

Bahnhofstrasse 9
2540 Grenchen
Switzerland

Phone +41 (0)32 655 71 11
Fax +41 (0)32 655 71 74

contact@eta.ch
www.eta.ch