

A

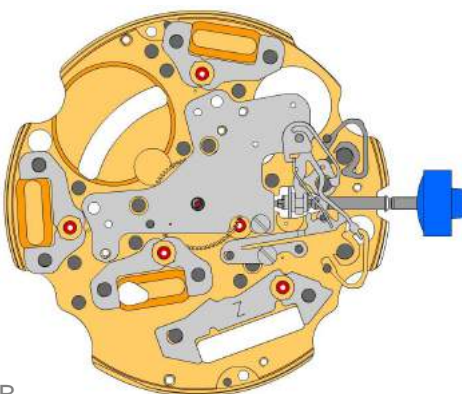
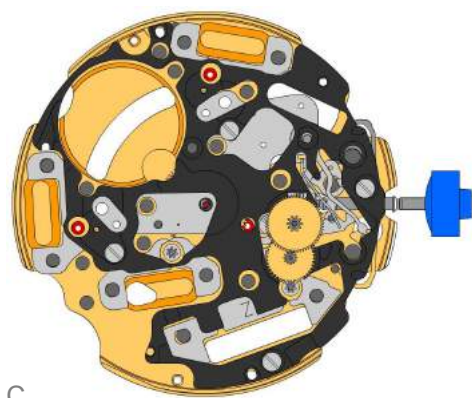

B

2000.574.G 1.		Platine
3305.275.CO 2.		Chaussée avec entraîneur (Aig.1)
2030.039.CO 3.		Pont de centre Pont de centre tenue par 1 vis 4000.250.
4000.250 4.		Vis
3001.055.FI 5.		Pignon coulant
3000.177.CO 6.		Tige de mise à l'heure
3017.049 7.		Tirette
3905.049 8.		Sautoir de tirette (3 positions) Sautoir de tirette tenue par 1 vis 4000.250.
4000.250 9.		Vis
3015.081 10.		Bascule (3 positions) Les pièces 3015.081 et 3905.067 doivent être échangées ensemble.
3905.067 11.		Ressort de bascule Mise en tension du ressort.
3406.030 12.		Sautoir de poussoir B Fixer le sautoir de poussoir gris entre les deux piliers plus loin.
3406.038 13.		Sautoir de poussoir A Fixer le sautoir de poussoir jaune entre les deux piliers plus proche.
3622.040 14.		Stator Marquage [Z] sur le stator.
3622.039 15.		Stator (cpt 6h, 9h, chrono)
3622.039 16.		Stator (cpt 6h, 9h, chrono)
3622.039 17.		Stator (cpt 6h, 9h, chrono)

C

3603.079
18.  **Potence plastique**
Potence plastique tenue par 4 vis 4000.250.

4000.250
19.  **Vis**

3715.094.RK
20.  **Rotor**

3715.094.RK
21.  **Rotor**

3147.046.CO
22.  **Roue intermédiaire**

3136.142.CO
23.  **Roue de seconde (longue)**

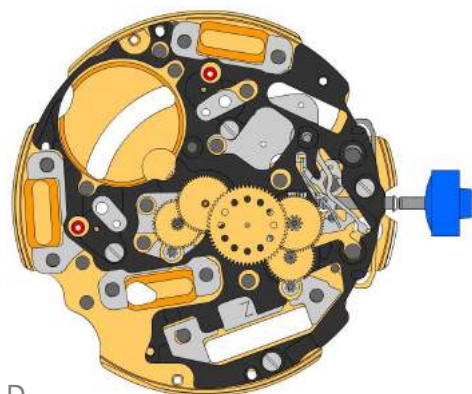
D

3147.047.CO
24.  **Roue intermédiaire (chrono)**

3136.143.CO
25.  **Roue de chronographe (Aig.1)**

3122.056.CO
26.  **Roue moyenne**

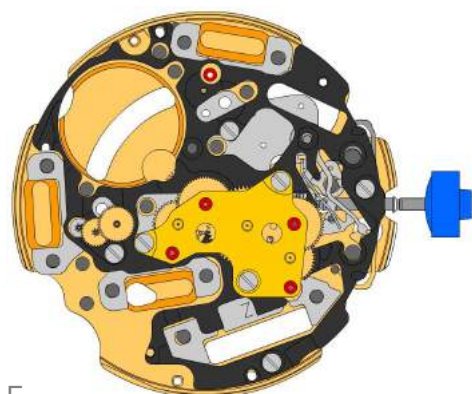

E

2020.148.G
27.  **Pont de rouage**
Pont de rouage tenue par 3 vis 4000.250.

4000.250
28.  **Vis**

3715.095.RK
29.  **Rotor**





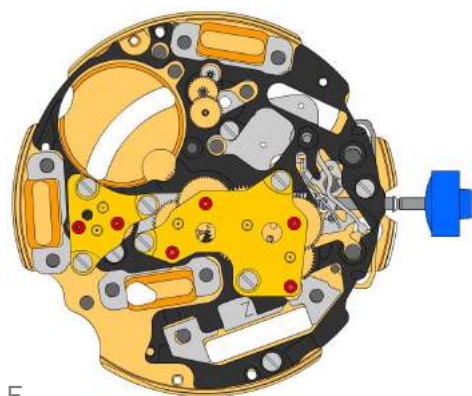

3147.048.CO
30.  **Roue intermédiaire (cpt)**

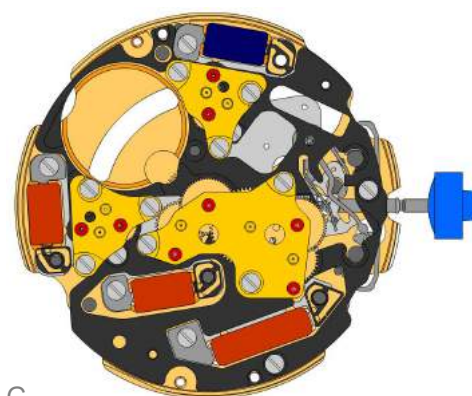
3402.006.CO
31.  **Roue compteuse de minutes**







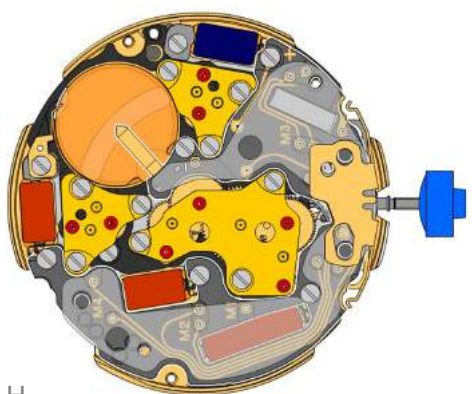

F

2020.149.G 32.		Pont de rouage compteur Pont de rouage compteur tenue par 3 vis 4000.250.
4000.250 33.		Vis
3715.095.RK 34.		Rotor
3147.053.CO 35.		Roue intermédiaire (cpt 1/10sec)
3402.016.CO 36.		Roue compteuse de 1/10 sec



G

2020.149.G 37.		Pont de rouage compteur Pont de rouage compteur tenue par 3 vis 4000.250.
4000.250 38.		Vis
3621.053.RK 39.		Bobine Attention: Prendre la bobine uniquement par le noyau de bobine gris. Bobine tenue par 1 vis 4000.250.
3621.054.RK 40.		Bobine (cpt 9h, chrono) Attention: Prendre la bobine uniquement par le noyau de bobine gris. Bobine tenue par 1 vis 4000.250.
3621.054.RK 41.		Bobine (cpt 9h, chrono) Attention: Prendre la bobine uniquement par le noyau de bobine gris. Bobine tenue par 1 vis 4000.250.
3621.055.RK 42.		Bobine (cpt 6h) Attention: Prendre la bobine uniquement par le noyau de bobine gris. Bobine tenue par 1 vis 4000.250.
4000.250 43.		Vis

H

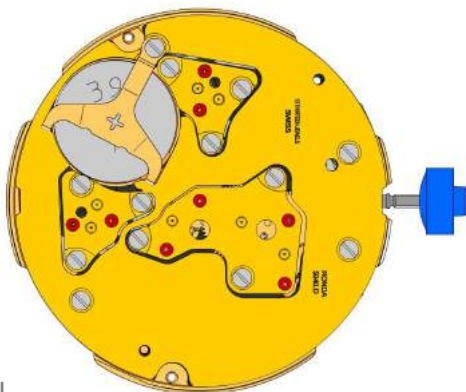
3601.118 44.		Bride contact Bride contact tenue par 1 vis 4000.250.
4000.250 45.		Vis
3603.034 46.		Isolateur pile
3612.144.5040 47.		Module électronique Module électronique tenue par 5 vis 4000.248. Les mesures électroniques peuvent être réaliser maintenant.
4000.248 48.		Vis
3603.069 49.		Isolateur de circuit
3601.107.G 50.		Ressort contact pousoirs



2130.137.G.M01.5040D
51.  **Couvre-module électronique**
Couvre-module électronique tenue par 3 vis 4000.250.

3600.010.HGF
52.  **Pile 395**

3601.109.G
53.  **Bride +**
Bride tenue par 1 vis 4000.250.

4000.250
54.  **Vis**

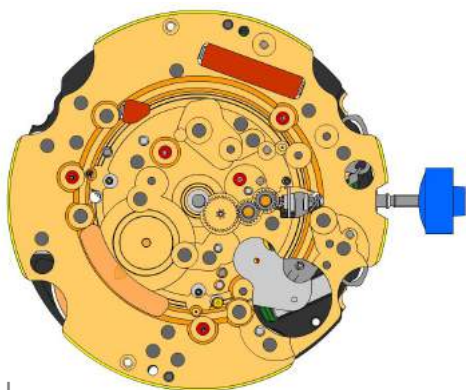

J

2000.574.G 55.		Platine
3004.164 56.		Renvoi
3004.164 57.		Renvoi
3007.054.CO 58.		Roue de minuterie

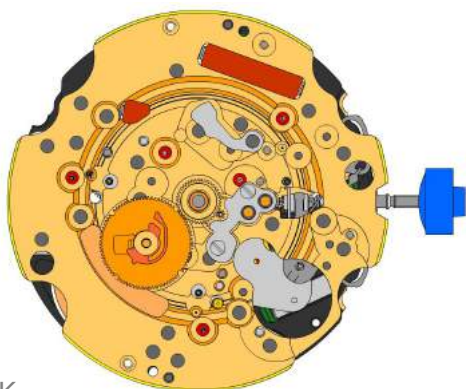

K

2130.143 59.		Pont du rouage de minuterie Pont du rouage de minuterie tenue par 2 vis 4000.305.
4000.305 60.		Vis
3301.241 61.		Roue des heures (Aig.1)
3315.016 62.		Clinquant
3004.224.CO 63.		Roue entraîneuse de quantième
3500.049 64.		Sautoir de quantième

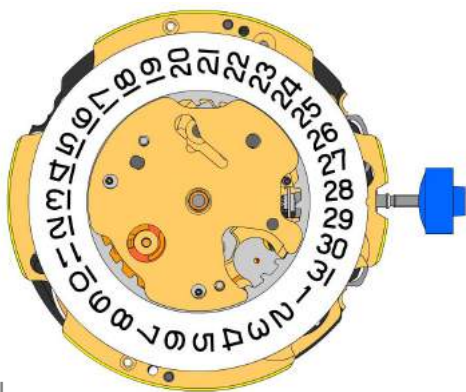

L

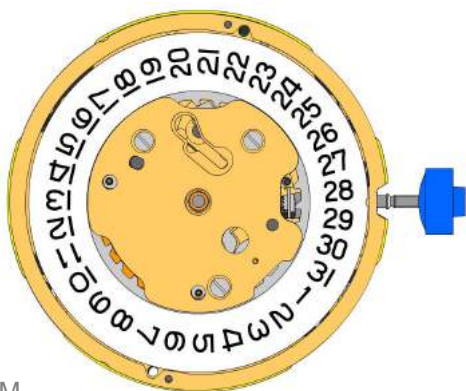

M

3504.208.AB.1.A 65.		Indicateur de quantité (standard) Marquage de l'indicateur à 3 heures.
2130.141 66.		Plaque de maintien de l'indicateur de quantité Plaque maintien indicateur de quantité tenue par 1 vis 4000.250.
3905.070 67.		Ressort sautoir de quantité Insertion du ressort sautoir de quantité dans l'ouverture.
2130.140.G 68.		Plaque de maintien du mécanisme de quantité Plaque maintien mécanisme de quantité tenue par 2 vis 4000.250.
4000.250 69.		Vis
3506.072.G 70.		Support de cadran
8200 71.		Moebius 8200
9014 72.		Moebius 9014
124 73.		Jismaa 124
9020 74.		Moebius 9020

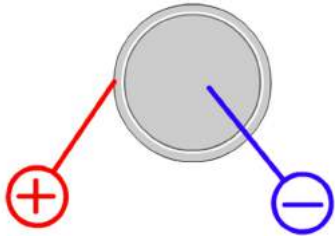

Pile	395
Tension	1.55 V

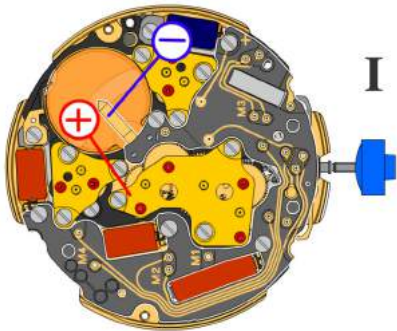

Tige de mise à l'heure en position I, calendrier hors engrenage, intervalle de mesure 60 s pour la marche et la consommation:

Consommation typique	1.32 μA
Consommation maximale	1.65 μA
Marche	-10s/M. .. +20s/M.
Limite inférieure de la tension de fonctionnement	1.20 V

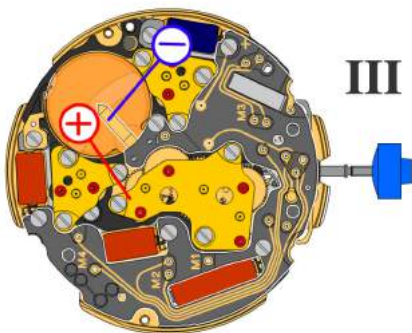

Tige de mise à l'heure en position III, intervalle de mesure 60 s:

Typical consumption	0.10 μA
Maximal consumption	0.30 μA

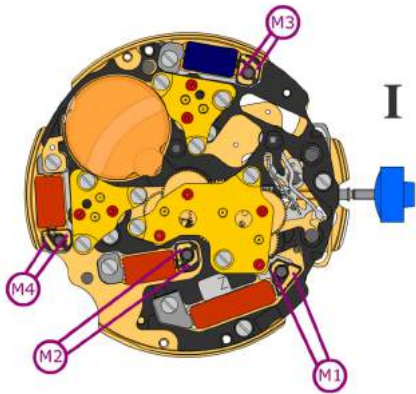

Résistance de la bobine M1 **1.90 k Ω .. 2.10 k Ω**

Résistance de la bobine M2 **1.68 k Ω .. 1.88 k Ω**

Résistance de la bobine M3 **1.68 k Ω .. 1.88 k Ω**

Résistance de la bobine M4 **1.68 k Ω .. 1.88 k Ω**

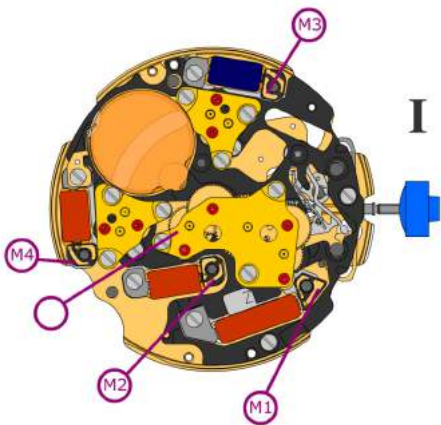

Isolation de la bobine
M1/M2/M3/M4 **∞ k Ω**

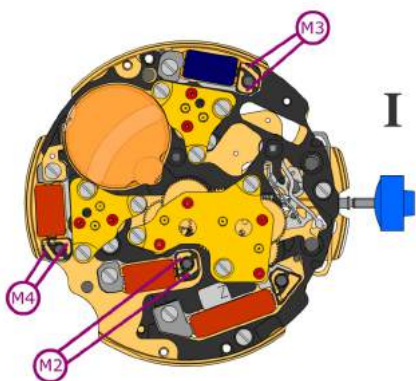

Générateur d'impulsion
(4.9 ms, 8 Hz):



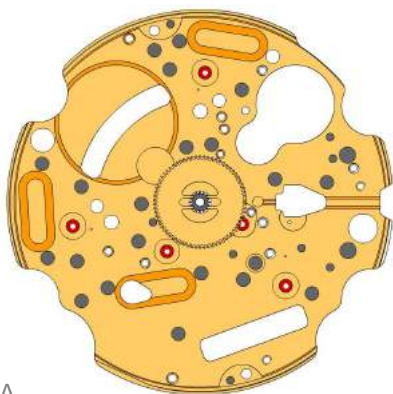



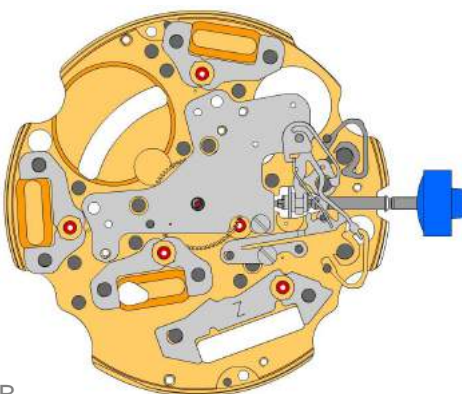

Limite inférieure de la tension de
fonctionnement M2/M3/M4 **1.20 V**



A



B

2000.574.G 1.		Main plate
3305.275.CO 2.		Cannon pinion with driver (Aig.1)
2030.039.CO 3.		Centre bridge Centre bridge held by 1 screw 4000.250.
4000.250 4.		Screw
3001.055.FI 5.		Sliding pinion
3000.177.CO 6.		Setting stem
3017.049 7.		Setting lever
3905.049 8.		Setting lever jumper (3 positions) Setting lever jumper held by 1 screw 4000.250.
4000.250 9.		Screw
3015.081 10.		Yoke (3 positions) Parts 3015.081 and 3905.067 must be exchanged together.
3905.067 11.		Yoke spring Tensioning the spring arm.
3406.030 12.		Pusher jumper B Put the grey jumper between the two posts on the further side.
3406.038 13.		Pusher jumper A Put the yellow jumper between the two posts on the closer side.
3622.040 14.		Stator Mark [Z] on stator.
3622.039 15.		Stator (counter 6h, 9h, chrono)
3622.039 16.		Stator (counter 6h, 9h, chrono)
3622.039 17.		Stator (counter 6h, 9h, chrono)

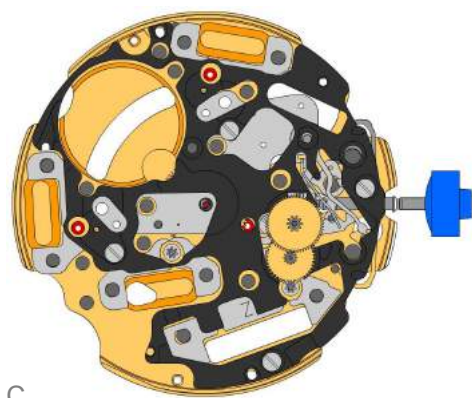
C

3603.079
18.  **Plastic bracket**
Plastic bracket held by 4 screws 4000.250.

4000.250
19.  **Screw**

3715.094.RK
20.  **Rotor**

3715.094.RK
21.  **Rotor**

3147.046.CO
22.  **Intermediate wheel**

3136.142.CO
23.  **Second wheel (long)**

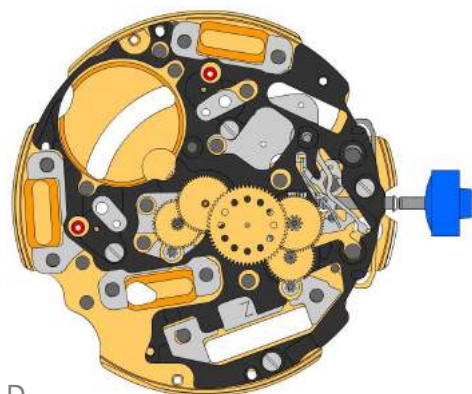

D

3147.047.CO
24.  **Intermediate wheel (chrono)**

3136.143.CO
25.  **Chronograph wheel (Fig.1)**

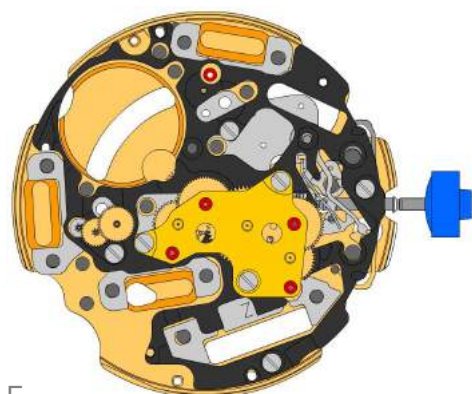
3122.056.CO
26.  **Third wheel**

E

2020.148.G
27.  **Train wheel bridge**
Train wheel bridge held by 3 screws 4000.250.

4000.250
28.  **Screw**



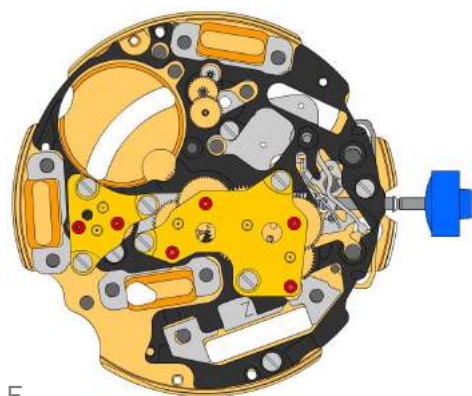

3715.095.RK
29.  **Rotor**

3147.048.CO
30.  **Intermediate wheel (counter)**

3402.006.CO
31.  **Minute counting wheel**







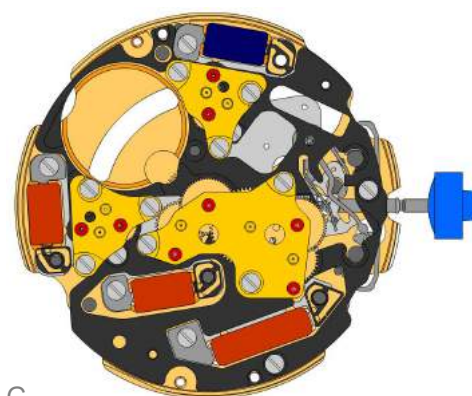

F

2020.149.G 32.		Counter train wheel bridge Counter train wheel bridge held by 3 screws 4000.250.
4000.250 33.		Screw
3715.095.RK 34.		Rotor
3147.053.CO 35.		Intermediate wheel (counter 1/10sec)
3402.016.CO 36.		Counting wheel 1/10 sec







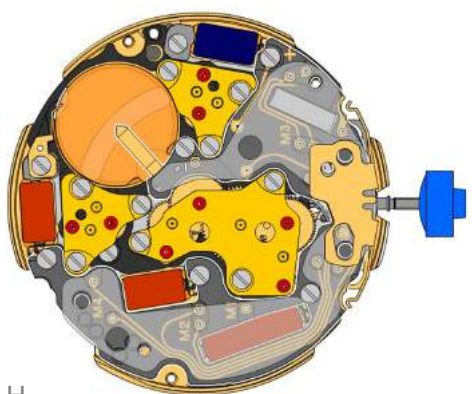

G

2020.149.G 37.		Counter train wheel bridge Counter train wheel bridge held by 3 screws 4000.250.
4000.250 38.		Screw
3621.053.RK 39.		Coil Attention: Please hold the coil only on the grey coil core. Coil held by 1 screw 4000.250.
3621.054.RK 40.		Coil (counter 9h, chrono) Attention: Please hold the coil only on the grey coil core. Coil held by 1 screw 4000.250.
3621.054.RK 41.		Coil (counter 9h, chrono) Attention: Please hold the coil only on the grey coil core. Coil held by 1 screw 4000.250.
3621.055.RK 42.		Coil (counter 6h) Attention: Please hold the coil only on the grey coil core. Coil held by 1 screw 4000.250.
4000.250 43.		Screw



H

3601.118 44.		Contact strip Contact strip held by 1 screw 4000.250.
4000.250 45.		Screw
3603.034 46.		Battery insulator
3612.144.5040 47.		Electronic module Electronic module held by 5 screws 4000.248. Electronic measurements may be realised now.
4000.248 48.		Screw
3603.069 49.		Circuit insulator
3601.107.G 50.		Pusher contact spring

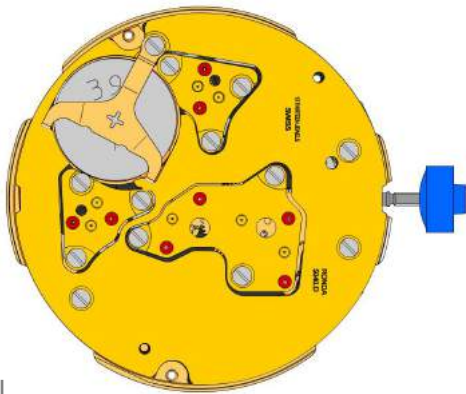

2130.137.G.M01.5040D
51.  **Electronic module cover**
Electronic module cover held by 3 screws 4000.250.



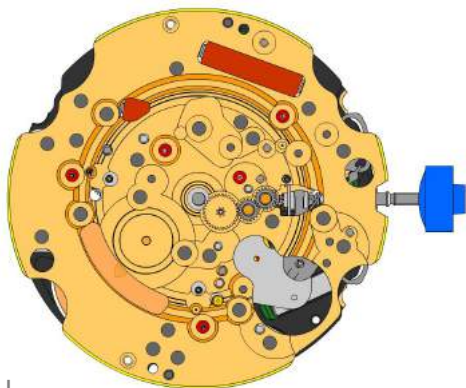

3600.010.HGF
52.  **Battery 395**

3601.109.G
53.  **Bridge +**
Bridge held by 1 screw 4000.250.

4000.250
54.  **Screw**







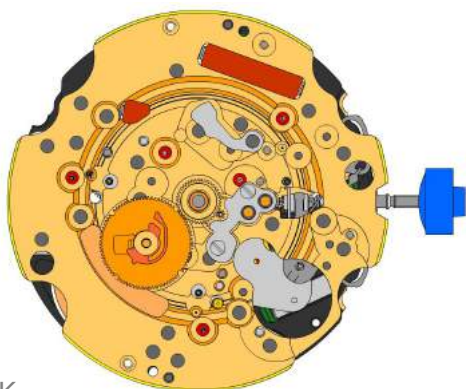

J

2000.574.G 55.		Main plate
3004.164 56.		Setting wheel
3004.164 57.		Setting wheel
3007.054.CO 58.		Minute wheel



K



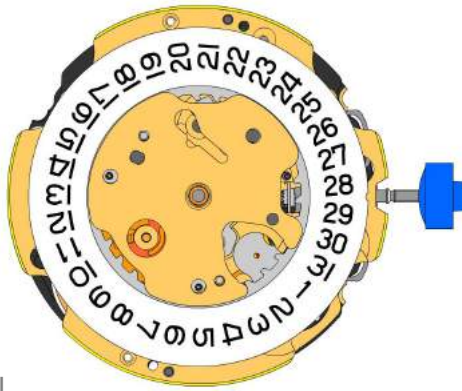



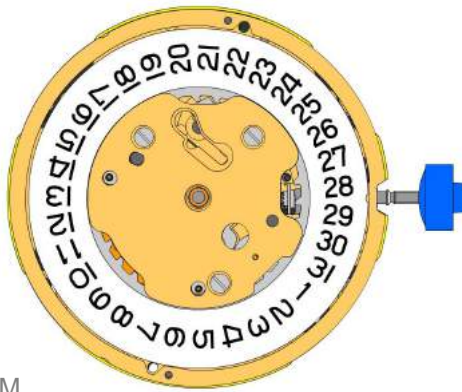



2130.143 59.		Minute train bridge Minute train bridge held by 2 screws 4000.305.
4000.305 60.		Screw
3301.241 61.		Hour wheel (Aig.1)
3315.016 62.		Friction spring
3004.224.CO 63.		Date indicator driving wheel
3500.049 64.		Date jumper



L



M

3504.208.AB.1.A 65.		Date indicator (standard) Nick of the indicator at 3 o'clock.
2130.141 66.		Date indicator maintaining plate Date indicator maintaining plate held by 1 screw 4000.250.
3905.070 67.		Date jumper spring Insert the date jumper spring in the provided opening.
2130.140.G 68.		Date mechanism maintaining plate Date mechanism maintaining plate held by 2 screws 4000.250.
4000.250 69.		Screw
3506.072.G 70.		Dial support
8200 71.		Moebius 8200
9014 72.		Moebius 9014
124 73.		Jismaa 124
9020 74.		Moebius 9020

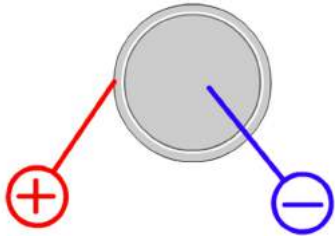

Battery	395
Voltage	1.55 V

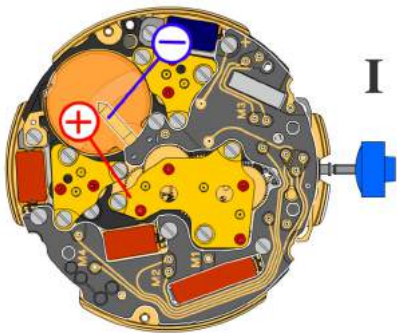

*Setting stem in position I, calendar not in gear,
60 s measuring interval for rate and consumption:*

Typical consumption	1.32 μA
Maximal consumption	1.65 μA
Rate	-10s/M. .. +20s/M.
Lower working voltage limit	1.20 V

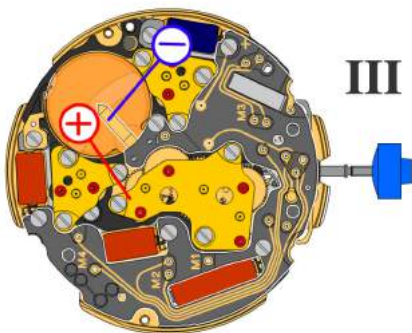

Setting stem in position III, 60 s measuring interval:

Typical consumption	0.10 μA
Maximal consumption	0.30 μA

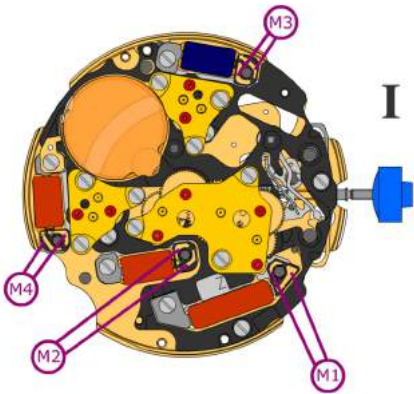

Coil resistance M1 **1.90 k Ω .. 2.10 k Ω**

Coil resistance M2 **1.68 k Ω .. 1.88 k Ω**

Coil resistance M3 **1.68 k Ω .. 1.88 k Ω**

Coil resistance M4 **1.68 k Ω .. 1.88 k Ω**

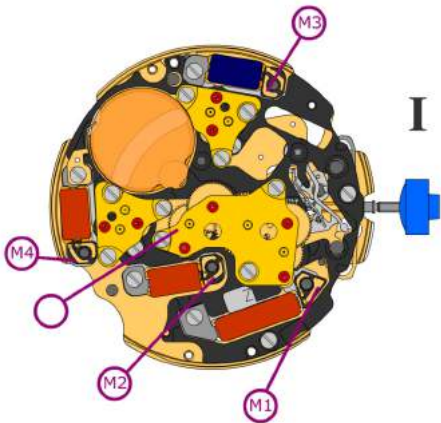

Coil isolation M1/M2/M3/M4 **∞ k Ω**

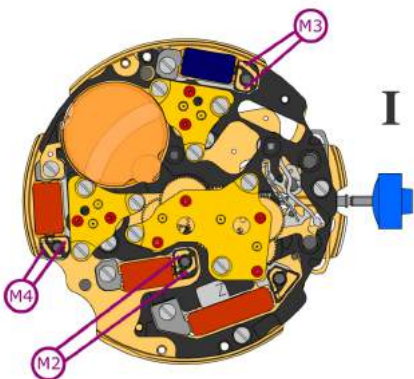

Signal generator (4.9 ms, 8 Hz):



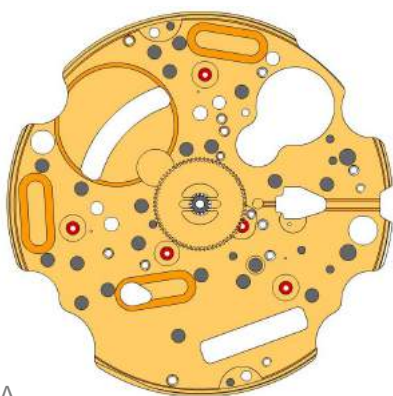



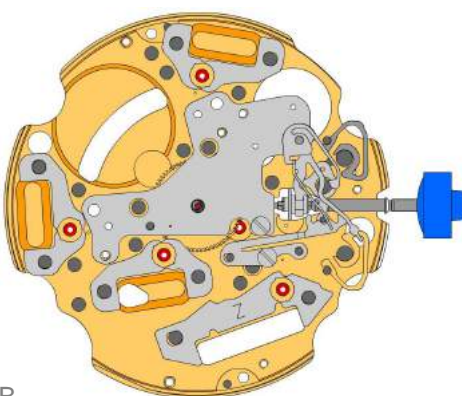



Lower working voltage limit M2/M3/M4 **1.20 V**



A







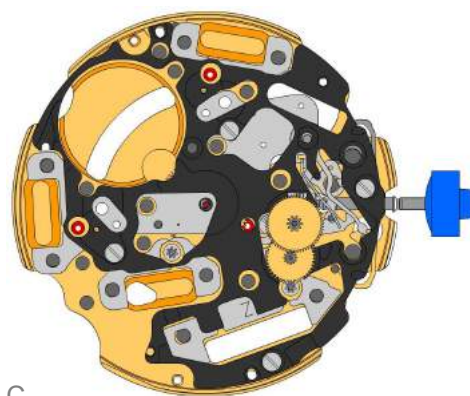

B

2000.574.G 1.		Werkplatte
3305.275.CO 2.		Minutenrohr mit Mitnehmer (Aig.1)
2030.039.CO 3.		Zentrumbrücke Zentrumbrücke gehalten durch 1 Schraube 4000.250.
4000.250 4.		Schraube
3001.055.FI 5.		Kupplungstrieb
3000.177.CO 6.		Stellwelle
3017.049 7.		Winkelhebel
3905.049 8.		Winkelhebelraste (3 Positionen) Winkelhebelraste gehalten durch 1 Schraube 4000.250.
4000.250 9.		Schraube
3015.081 10.		Wippe (3 Positionen) Die Teile 3015.081 und 3905.067 sind zusammen auszutauschen.
3905.067 11.		Wippenfeder Den Federarm spannen.
3406.030 12.		Drückerraste B Graue Drückerraste zwischen den beiden Säulen auf der entfernteren Seite platzieren.
3406.038 13.		Drückerraste A Gelbe Drückerraste zwischen den beiden Säulen auf der näheren Seite platzieren.
3622.040 14.		Stator Markierung [Z] auf Stator.
3622.039 15.		Stator (Zähler 6h, 9h, Chrono)
3622.039 16.		Stator (Zähler 6h, 9h, Chrono)
3622.039 17.		Stator (Zähler 6h, 9h, Chrono)



C

3603.079 18.		Kunststoffhalterung Kunststoffhalterung gehalten durch 4 Schrauben 4000.250.
4000.250 19.		Schraube
3715.094.RK 20.		Rotor
3715.094.RK 21.		Rotor
3147.046.CO 22.		Zwischenrad
3136.142.CO 23.		Sekundenrad (lang)

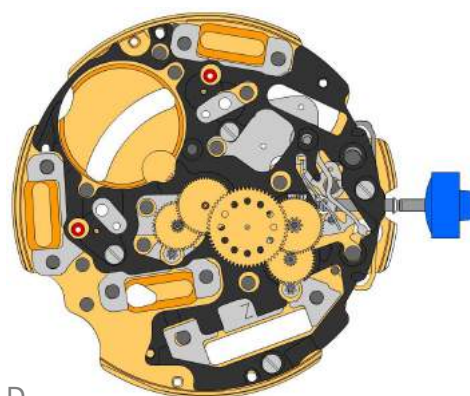

D

3147.047.CO 24.		Zwischenrad (Chrono)
3136.143.CO 25.		Chrono-Zentrumrad (Aig.1)
3122.056.CO 26.		Kleinbodenrad

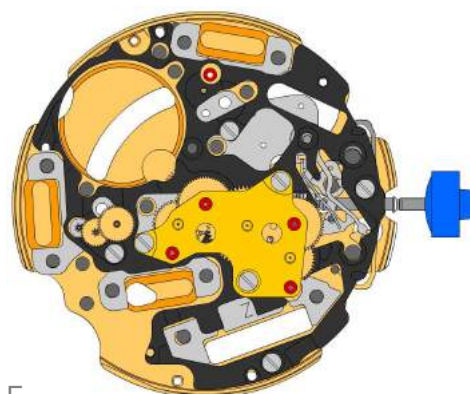



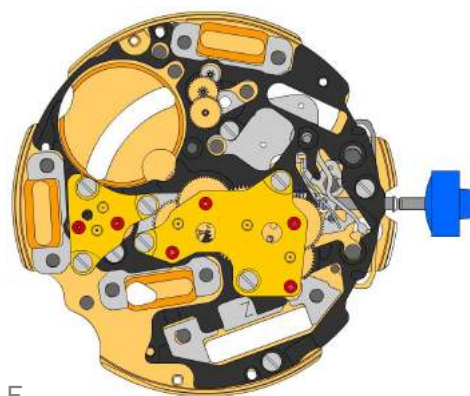

E

2020.148.G 27.		Räderwerkbrücke Räderwerkbrücke gehalten durch 3 Schrauben 4000.250.
4000.250 28.		Schraube
3715.095.RK 29.		Rotor
3147.048.CO 30.		Zwischenrad (Zähler)
3402.006.CO 31.		Minutenzählrad







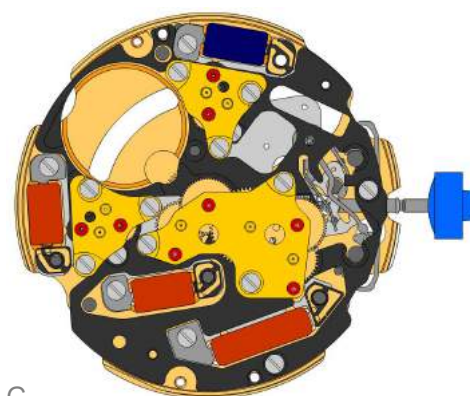

F

2020.149.G 32.		Zähler-Räderwerkbrücke Zähler-Räderwerkbrücke gehalten durch 3 Schrauben 4000.250.
4000.250 33.		Schraube
3715.095.RK 34.		Rotor
3147.053.CO 35.		Zwischenrad (Zähler 1/10sek)
3402.016.CO 36.		Zählrad 1/10 sek







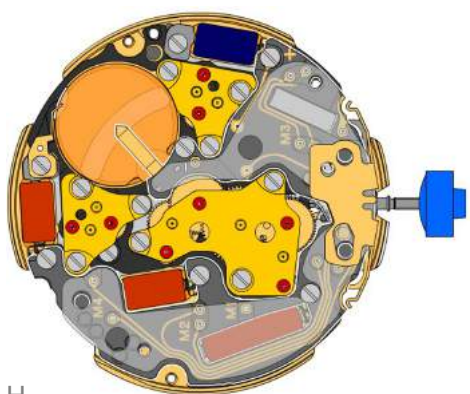

G





2020.149.G 37.		Zähler-Räderwerkbrücke Zähler-Räderwerkbrücke gehalten durch 3 Schrauben 4000.250.
4000.250 38.		Schraube
3621.053.RK 39.		Spule Achtung: Spule nur am grauen Spulenkern halten. Spule gehalten durch 1 Schraube 4000.250.
3621.054.RK 40.		Spule (Zähler 9h, Chrono) Achtung: Spule nur am grauen Spulenkern halten. Spule gehalten durch 1 Schraube 4000.250.
3621.054.RK 41.		Spule (Zähler 9h, Chrono) Achtung: Spule nur am grauen Spulenkern halten. Spule gehalten durch 1 Schraube 4000.250.
3621.055.RK 42.		Spule (Zähler 6h) Achtung: Spule nur am grauen Spulenkern halten. Spule gehalten durch 1 Schraube 4000.250.
4000.250 43.		Schraube

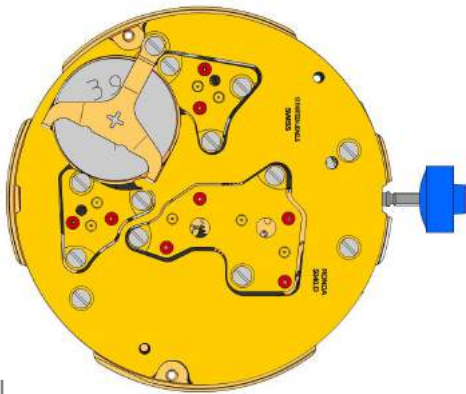

H

3601.118 44.		Kontaktbügel Kontaktbügel gehalten durch 1 Schraube 4000.250.
4000.250 45.		Schraube
3603.034 46.		Isolation für Batterie
3612.144.5040 47.		Elektronikmodul Elektronikmodul gehalten durch 5 Schrauben 4000.248. Elektronische Messungen können nun vorgenommen werden.
4000.248 48.		Schraube
3603.069 49.		Isolation für Schaltung
3601.107.G 50.		Drückerkontaktfeder



2130.137.G.M01.5040D 51.		Deckplatte für Elektronikmodul Deckplatte für Elektronikmodul gehalten durch 3 Schrauben 4000.250.festschrauben.
3600.010.HGF 52.		Batterie 395
3601.109.G 53.		Bügel + Bügel gehalten durch 1 Schraube 4000.250.
4000.250 54.		Schraube

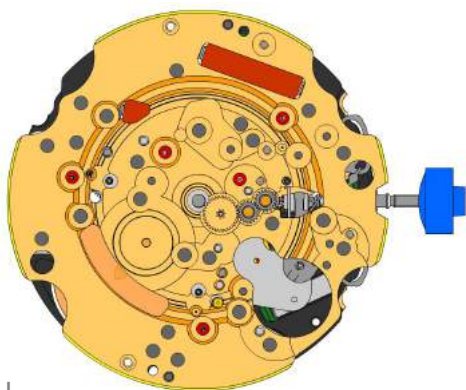

J

 2000.574.G
55. Werkplatte

 3004.164
56. Zeigerstellrad

 3004.164
57. Zeigerstellrad

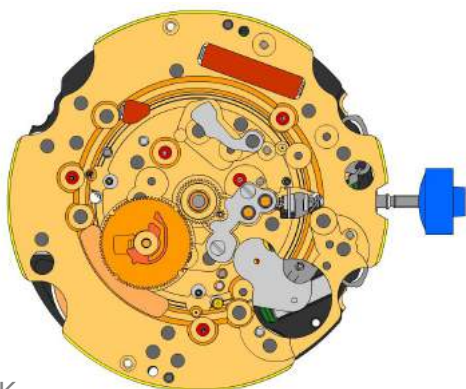
 3007.054.CO
58. Wechselrad

K

 2130.143
59. Wechselradbrücke
Wechselradbrücke gehalten durch 2 Schrauben 4000.250.

 4000.305
60. Schraube

 3301.241
61. Stundenrad (Aig.1)

 3315.016
62. Friktionsfeder

 3004.224.CO
63. Datumzeiger-Mitnehmerrad



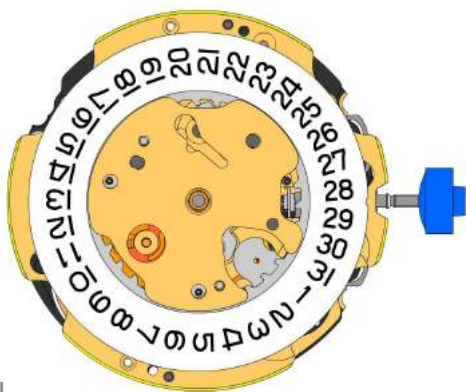



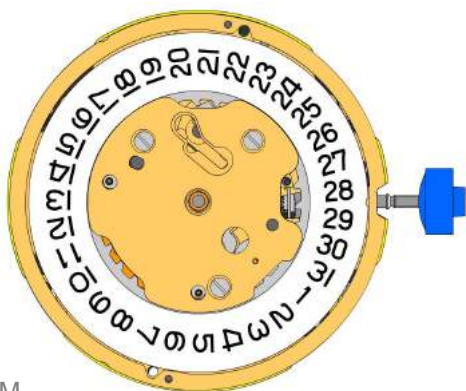



 3500.049
64. Datumraste





L

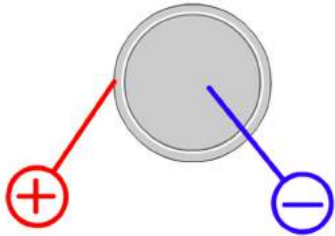

M

3504.208.AB.1.A 65.		Datumsanzeiger (Standard) Einbuchtung im Disc bei 3 Uhr.
2130.141 66.		Halteplatte für Datumsanzeige Halteplatte für Datumsanzeige gehalten durch 1 Schraube 4000.250.
3905.070 67.		Feder für Datumraste Feder für Datumraste in die Öffnung einfügen.
2130.140.G 68.		Halteplatte für Datum-Mechanismus Halteplatte für Datum-Mechanismus gehalten durch 2 Schrauben 4000.250.
4000.250 69.		Schraube
3506.072.G 70.		Träger für Zifferblatt
8200 71.		Moebius 8200
9014 72.		Moebius 9014
124 73.		Jismaa 124
9020 74.		Moebius 9020



Batterie	395
Spannung	1.55 V

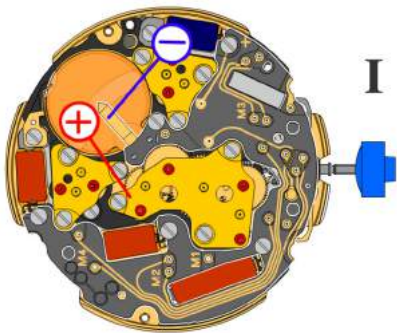

*Stellwelle in Position I, Kalender nicht im Eingriff,
60 s Messintervall für Gang und Verbrauch:*

Typischer Verbrauch	1.32 μA
Maximaler Verbrauch	1.65 μA
Gang	-10s/M. .. +20s/M.
Untere Funktionsspannungsgrenze	1.20 V

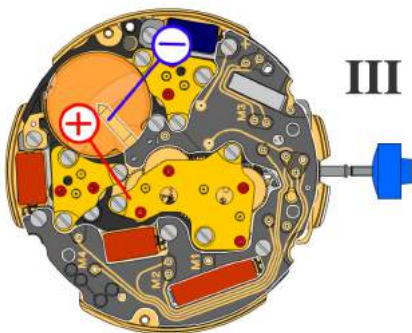

Stellwelle in Position III, 60 s Messintervall:

Typischer Verbrauch	0.10 μA
Maximaler Verbrauch	0.30 μA

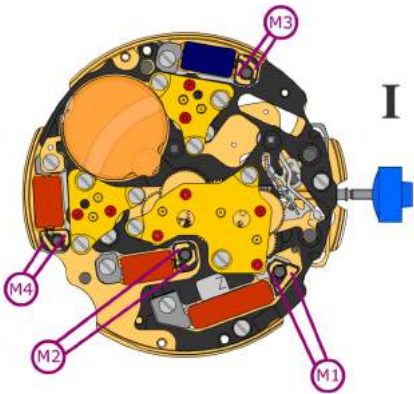

Spulenwiderstand M1 **1.90 k Ω .. 2.10 k Ω**

Spulenwiderstand M2 **1.68 k Ω .. 1.88 k Ω**

Spulenwiderstand M3 **1.68 k Ω .. 1.88 k Ω**

Spulenwiderstand M4 **1.68 k Ω .. 1.88 k Ω**

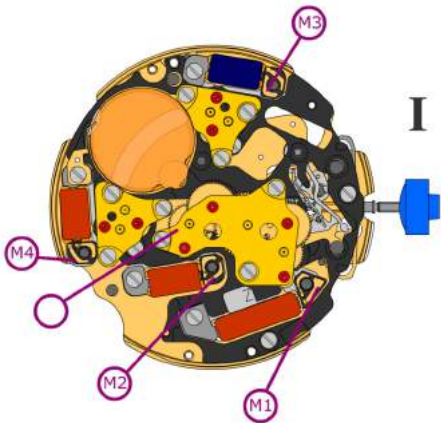

Spulenisolation M1/M2/M3/M4 **∞ k Ω**

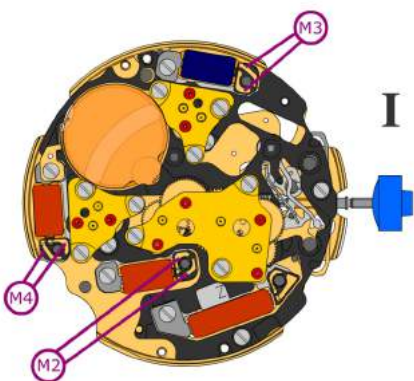

Pulsgenerator (4.9 ms, 8 Hz):

Untere Funktionsspannungsgrenze M2/M3/M4 **1.20 V**