

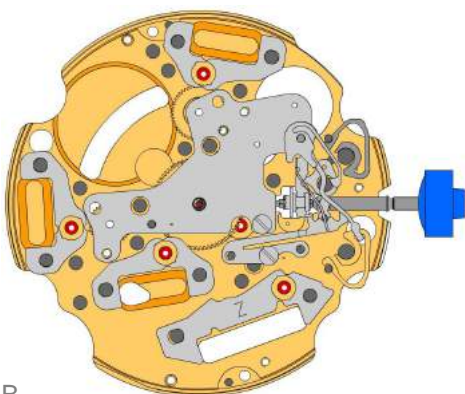

















A

B



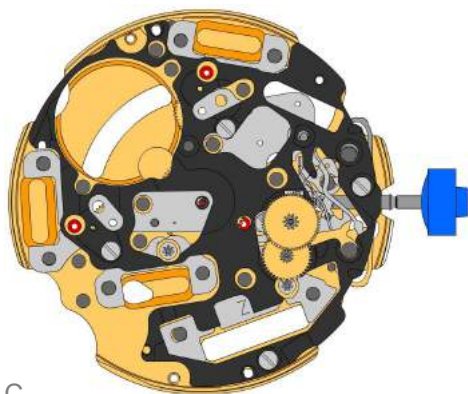

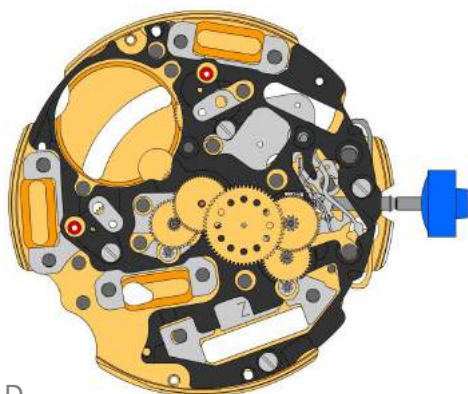
2000.574.G 1.		Platine
3305.282.CO 2.		Chaussée avec entraîneur (Aig.2)
3301.244.CO 3.		Roue des heures (cpt 24h) (Chrono)
3301.243.CO 4.		Roue des heures (cpt 12h) (Alarme)

2030.017.CO 5.		Pont de centre Pont de centre tenue par 1 vis 4000.250. Les pièces 2030.017.CO, 3004.223 et 3500.059 doivent être échangées ensemble.
4000.250 6.		Vis
3001.055.FI 7.		Pignon coulant
3000.177.CO 8.		Tige de mise à l'heure
3017.049 9.		Tirette
3905.049 10.		Sautoir de tirette (3 positions) Sautoir de tirette tenue par 1 vis 4000.250.
4000.250 11.		Vis
3015.081 12.		Bascule (3 positions) Les pièces 3015.081 et 3905.067 doivent être échangées ensemble.
3905.067 13.		Ressort de bascule Mise en tension du ressort. Les pièces 3015.081 et 3905.067 doivent être échangées ensemble.-#13;
3406.030 14.		Sautoir de poussoir B Fixer le sautoir de poussoir gris entre les deux piliers plus loin.
3406.038 15.		Sautoir de poussoir A Fixer le sautoir de poussoir jaune entre les deux piliers plus proche.
3622.040 16.		Stator Marquage [Z] sur le stator.
3622.039 17.		Stator (cpt 6h, 9h, chrono)
3622.039 18.		Stator (cpt 6h, 9h, chrono)
3622.039 19.		Stator (cpt 6h, 9h, chrono)





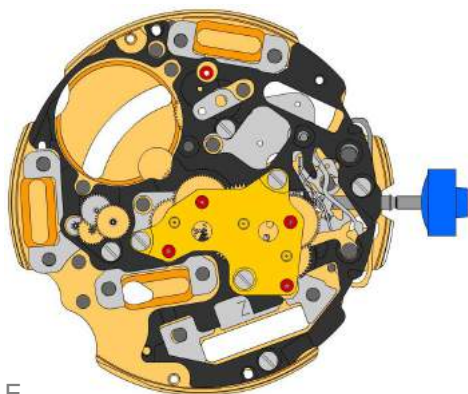

C

3603.079 20.		Potence plastique Potence plastique tenue par 4 vis 4000.250.
4000.250 21.		Vis
3715.094.RK 22.		Rotor
3715.094.RK 23.		Rotor





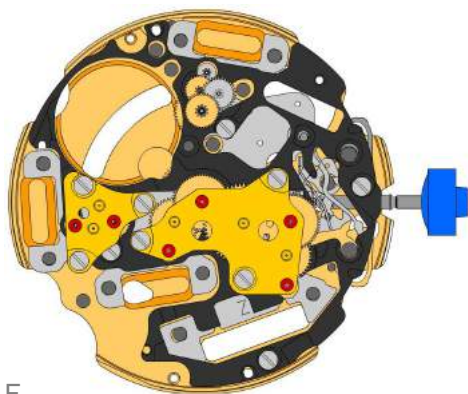

D

3147.046.CO 24.		Roue intermédiaire
3136.142.CO 25.		Roue de seconde (longue)
3147.047.CO 26.		Roue intermédiaire (chrono)
3136.144.CO 27.		Roue de chronographe (Aig.2)
3122.056.CO 28.		Roue moyenne







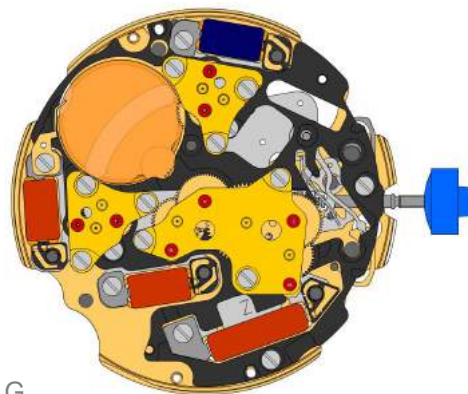

E

2020.148.G 29.		Pont de rouage Pont de rouage tenue par 3 vis 4000.250.
4000.250 30.		Vis
3715.095.RK 31.		Rotor
3147.048.CO 32.		Roue intermédiaire (cpt)
3007.056.CO 33.		Roue de minuterie (cpt 24h)
3402.008.CO 34.		Roue compteuse de minutes



F

2020.149.G 35.		Pont de rouage compteur Pont de rouage compteur tenue par 3 vis 4000.250.
4000.250 36.		Vis
3715.095.RK 37.		Rotor
3147.048.CO 38.		Roue intermédiaire (cpt)
3007.055.CO 39.		Roue de minuterie (cpt 12h)
3402.007.CO 40.		Roue compteuse de minutes

G

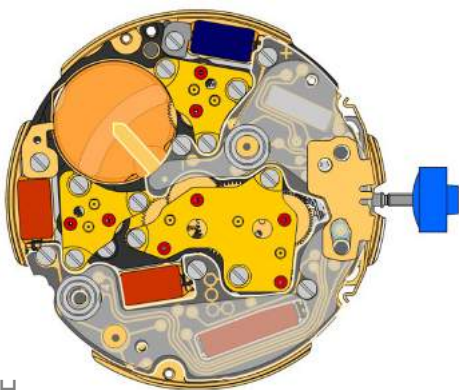
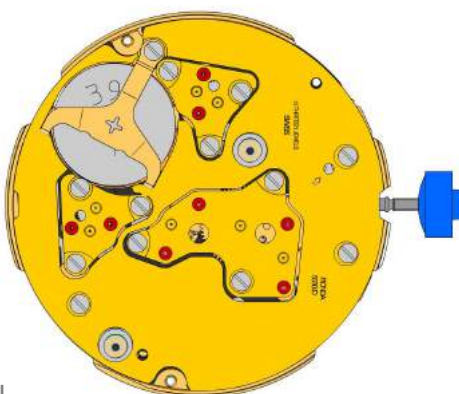
2020.149.G 41.		Pont de rouage compteur Pont de rouage compteur tenue par 3 vis 4000.250.
4000.250 42.		Vis
3621.053.RK 43.		Bobine Attention: Prendre la bobine uniquement par le noyau de bobine gris. Bobine tenue par 1 vis 4000.250.
3621.054.RK 44.		Bobine (cpt 9h, chrono) Attention: Prendre la bobine uniquement par le noyau de bobine gris. Bobine tenue par 1 vis 4000.250.
3621.054.RK 45.		Bobine (cpt 9h, chrono) Attention: Prendre la bobine uniquement par le noyau de bobine gris. Bobine tenue par 1 vis 4000.250.
3621.055.RK 46.		Bobine (cpt 6h) Attention: Prendre la bobine uniquement par le noyau de bobine gris. Bobine tenue par 1 vis 4000.250.
4000.250 47.		Vis

H

I

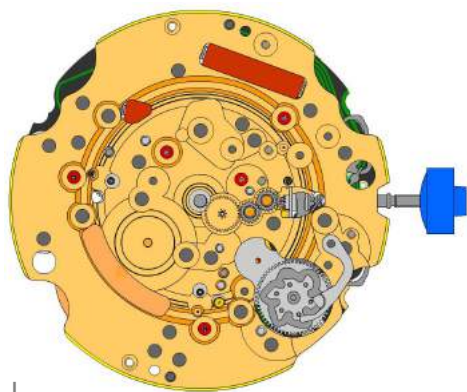
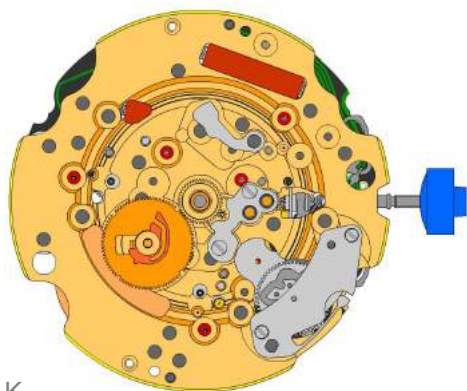
3601.118 48.		Bride contact Bride contact tenue par 1 vis 4000.250.
4000.250 49.		Vis
3603.034 50.		Isolateur pile
3612.176.5130 51.		Module électronique Module électronique tenue par 5 vis 4000.248. Les mesures électroniques peuvent être réalisées maintenant.
4000.248 52.		Vis
3603.069 53.		Isolateur de circuit
3603.070 54.		Isolateur de contact
3603.070 55.		Isolateur de contact
3601.107.G 56.		Ressort contact poussoirs
2130.159.G.M01.5130B 57.		Couvre-module électronique Couvre-module électronique tenue par 3 vis 4000.250.
3600.010.HGF 58.		Pile 395
3601.109.G 59.		Bride + Bride tenue par 1 vis 4000.250.
4000.250 60.		Vis

J

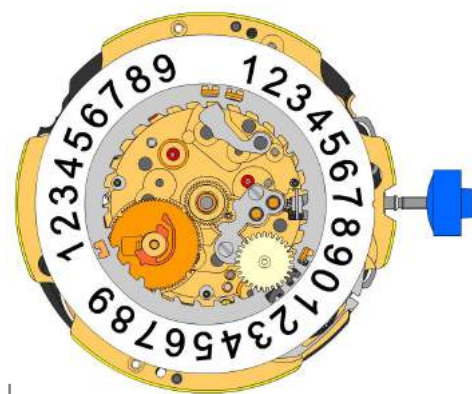
K

2000.574.G 61.		Platine
3004.164 62.		Renvoi
3004.164 63.		Renvoi
3007.054.CO 64.		Roue de minuterie
2130.143 65.		Pont du rouage de minuterie Pont du rouage de minuterie tenue par 2 vis 4000.305.
4000.305 66.		Vis
3004.223 67.		Roue entraîneuse des dizaines Les pièces 2030.017.CO, 3004.223 et 3500.059 doivent être échangées ensemble. Positionnement de la dent courte de la roue entraîneuse des dizaines en direction le centre du mouvement.
3500.059 68.		Sautoir des dizaines Les pièces 2030.017.CO, 3004.223 et 3500.059 doivent être échangées ensemble.
2130.142 69.		Plaque de maintien du sautoir des dizaines Plaque maintien sautoir des dizaines tenue par 2 vis 4000.306. Mise en tension du ressort.
4010.306 70.		Vis
3301.242 71.		Roue des heures (Aig.1)
3315.016 72.		Clinquant
3004.224.CO 73.		Roue entraîneuse de quantième
3500.049 74.		Sautoir de quantième



L

 3504.214.AF.1.A
75.

Indicateur des unités (standard)
Marquage de l'indicateur à 3 heures.

 3147.054
76.

Roue intermédiaire dizaines

 2130.141
77.

Plaque de maintien de l'indicateur de quantième
Plaque maintien indicateur de quantième tenue par 1 vis 4000.250.

 4000.250
78.

Vis

 3905.070
79.

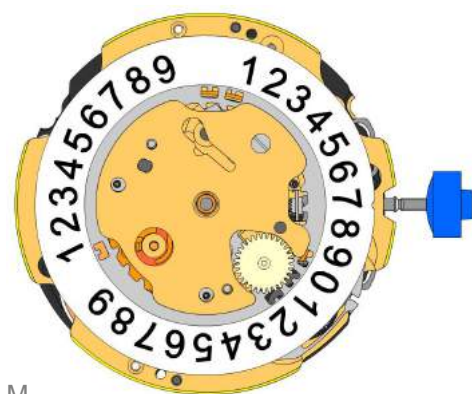
Ressort sautoir de quantième
Insertion du ressort sautoir de quantième dans l'ouverture.

M

 3504.216.AF.1.A
80.

Indicateur des dizaines (standard)
Marquage de l'indicateur à 3 heures.

 2130.140.G
81.

Plaque de maintien du mécanisme de quantième
Plaque maintien mécanisme de quantième tenue par 2 vis 4000.250.

 4000.250
82.

Vis

 3506.072.G
83.

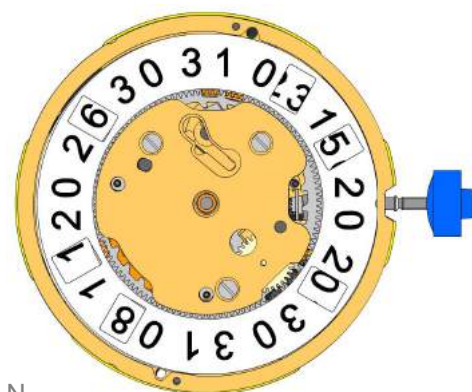
Support de cadran

N

 8200
84.

Moebius 8200

 9014
85.

Moebius 9014

 124
86.

Jismaa 124

 9020
87.

Moebius 9020

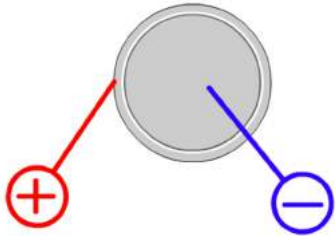

Pile	395
Tension	1.55 V

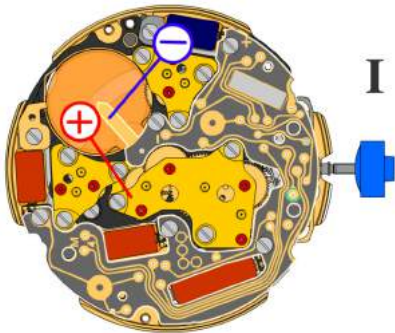

Tige de mise à l'heure en position I, calendrier hors engrenage, intervalle de mesure 60 s pour la marche et la consommation:

Consommation typique	1.48 μA
Consommation maximale	1.65 μA
Marche	-10s/M. .. +20s/M.
Limite inférieure de la tension de fonctionnement	1.20 V

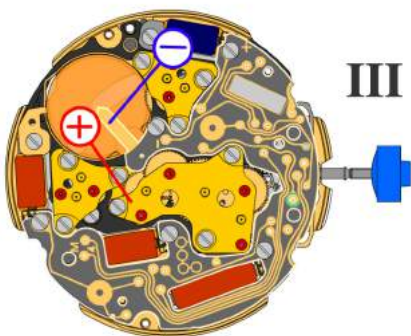

Tige de mise à l'heure en position III, intervalle de mesure 60 s:

Typical consumption	0.10 μA
Maximal consumption	0.30 μA

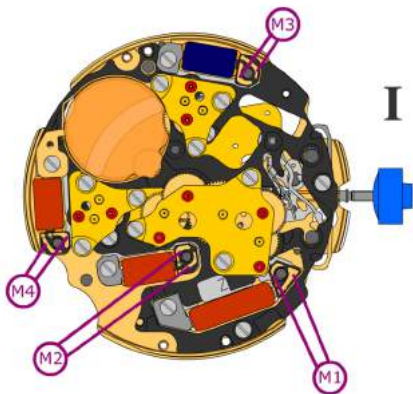

Résistance de la bobine M1 **1.90 kΩ .. 2.10 kΩ**

Résistance de la bobine M2 **1.68 kΩ .. 1.88 kΩ**

Résistance de la bobine M3 **1.68 kΩ .. 1.88 kΩ**

Résistance de la bobine M4 **1.68 kΩ .. 1.88 kΩ**

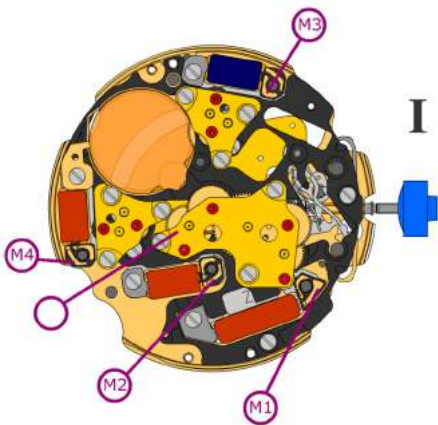

Isolation de la bobine
M1/M2/M3/M4 **∞ kΩ**

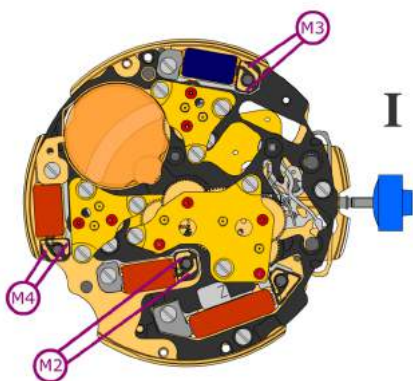

Générateur d'impulsion
(4.9 ms, 8 Hz):



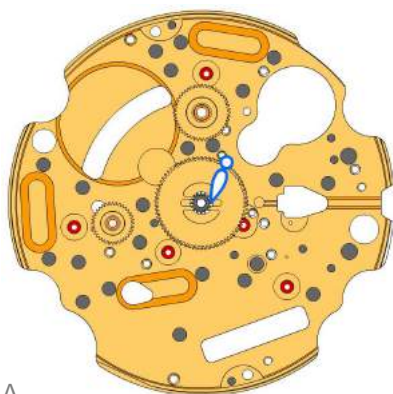

Limite inférieure de la tension de
fonctionnement M2/M3/M4 **1.20 V**

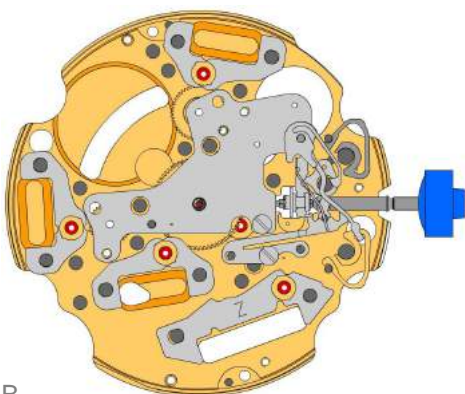















A







B

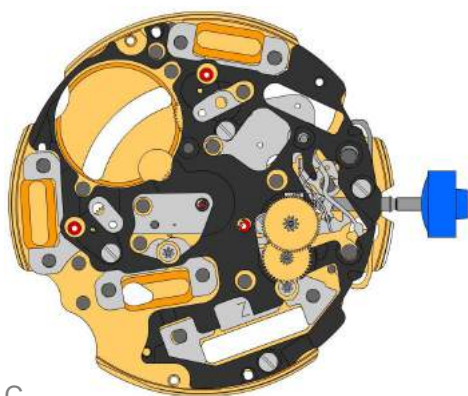



2000.574.G 1.		Main plate
3305.282.CO 2.		Cannon pinion with driver (Aig.2)
3301.244.CO 3.		Hour wheel (counter 24h) (Chrono)
3301.243.CO 4.		Hour wheel (counter 12h) (Alarm)

2030.017.CO 5.		Centre bridge Centre bridge held by 1 screw 4000.250. Parts 2030.017.CO, 3004.223 and 3500.059 must be exchanged together.
4000.250 6.		Screw
3001.055.FI 7.		Sliding pinion
3000.177.CO 8.		Setting stem
3017.049 9.		Setting lever
3905.049 10.		Setting lever jumper (3 positions) Setting lever jumper held by 1 screw 4000.250.
4000.250 11.		Screw
3015.081 12.		Yoke (3 positions) Parts 3015.081 and 3905.067 must be exchanged together.
3905.067 13.		Yoke spring Tensioning the spring arm. Parts 3015.081 and 3905.067 must be exchanged together.
3406.030 14.		Pusher jumper B Put the grey jumper between the two posts on the further side.
3406.038 15.		Pusher jumper A Put the yellow jumper between the two posts on the closer side.
3622.040 16.		Stator Mark [Z] on stator.
3622.039 17.		Stator (counter 6h, 9h, chrono)
3622.039 18.		Stator (counter 6h, 9h, chrono)
3622.039 19.		Stator (counter 6h, 9h, chrono)

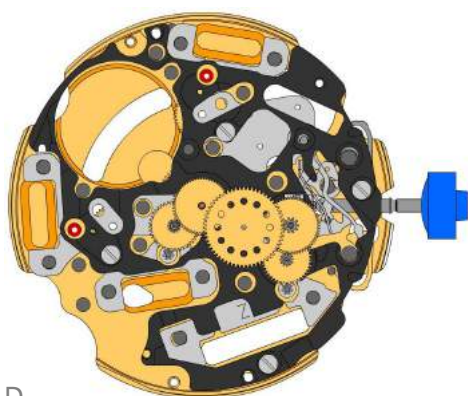



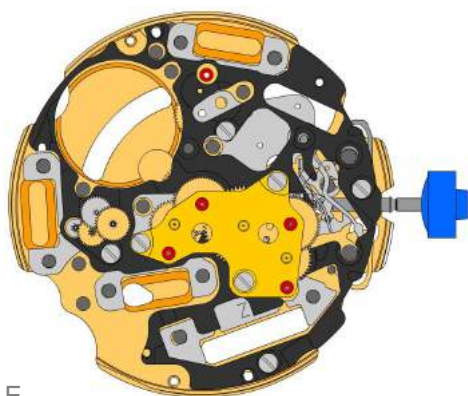

C

3603.079 20.		Plastic bracket Plastic bracket held by 4 screws 4000.250.
4000.250 21.		Screw
3715.094.RK 22.		Rotor
3715.094.RK 23.		Rotor





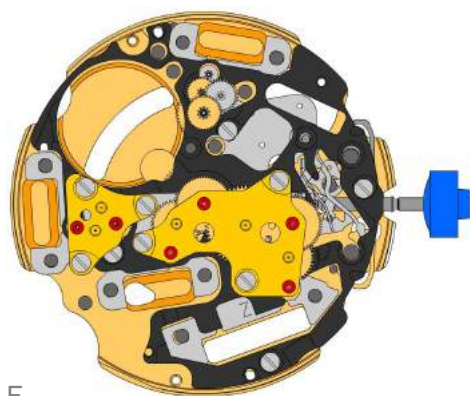

D

3147.046.CO 24.		Intermediate wheel
3136.142.CO 25.		Second wheel (long)
3147.047.CO 26.		Intermediate wheel (chrono)
3136.144.CO 27.		Chronograph wheel (Aig.2)
3122.056.CO 28.		Third wheel







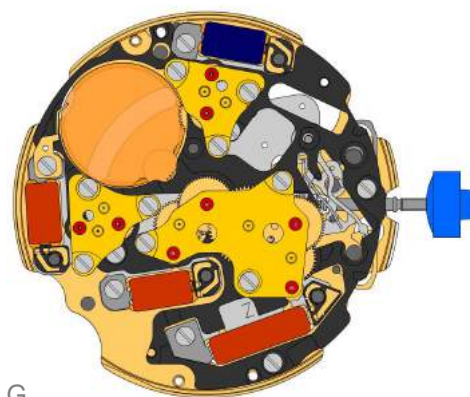

E

2020.148.G 29.		Train wheel bridge Train wheel bridge held by 3 screws 4000.250.
4000.250 30.		Screw
3715.095.RK 31.		Rotor
3147.048.CO 32.		Intermediate wheel (counter)
3007.056.CO 33.		Minute wheel (counter 24h)
3402.008.CO 34.		Minute counting wheel









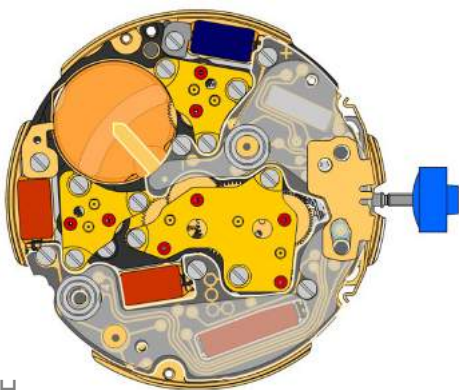
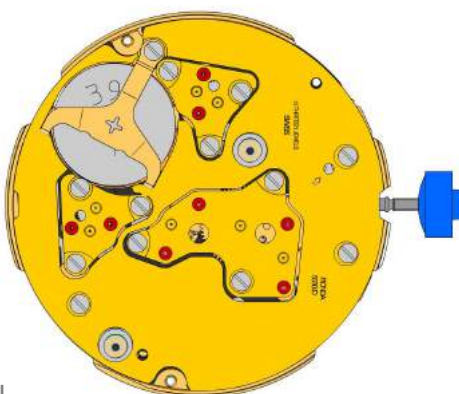





F

2020.149.G 35.		Counter train wheel bridge Train wheel bridge held by 3 screws 4000.250.
4000.250 36.		Screw
3715.095.RK 37.		Rotor
3147.048.CO 38.		Intermediate wheel (counter)
3007.055.CO 39.		Minute wheel (counter 12h)
3402.007.CO 40.		Minute counting wheel









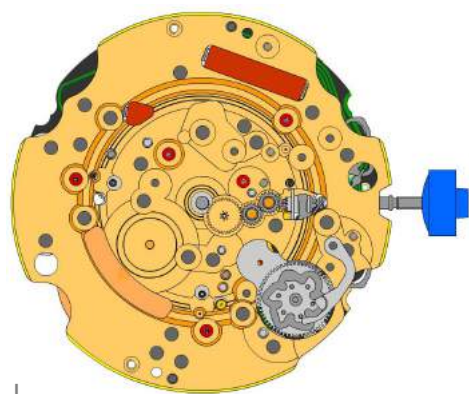
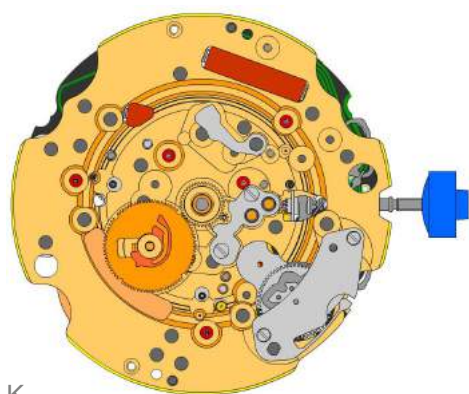





G

2020.149.G 41.		Counter train wheel bridge Train wheel bridge held by 3 screws 4000.250.
4000.250 42.		Screw
3621.053.RK 43.		Coil Attention: Please hold the coil only on the grey coil core. Coil held by 1 screw 4000.250.
3621.054.RK 44.		Coil (counter 9h, chrono) Attention: Please hold the coil only on the grey coil core. Coil held by 1 screw 4000.250.
3621.054.RK 45.		Coil (counter 9h, chrono) Attention: Please hold the coil only on the grey coil core. Coil held by 1 screw 4000.250.
3621.055.RK 46.		Coil (counter 6h) Attention: Please hold the coil only on the grey coil core. Coil held by 1 screw 4000.250.
4000.250 47.		Screw

H

I





3601.118 48.		Contact strip Contact strip held by 1 screw 4000.250.
4000.250 49.		Screw
3603.034 50.		Battery insulator
3612.176.5130 51.		Electronic module Electronic module held by 5 screws 4000.248. Electronic measurements may be realised now.
4000.248 52.		Screw
3603.069 53.		Circuit insulator
3603.070 54.		Contact insulator
3603.070 55.		Contact insulator
3601.107.G 56.		Pusher contact spring
2130.159.G.M01.5130B 57.		Electronic module cover Electronic module cover held by 1 screw 4000.250.
3600.010.HGF 58.		Battery 395
3601.109.G 59.		Bridle + Bridle held by 1 screw 4000.250.
4000.250 60.		Screw



J

K

2000.574.G 61.		Main plate
3004.164 62.		Setting wheel
3004.164 63.		Setting wheel
3007.054.CO 64.		Minute wheel
2130.143 65.		Minute train bridge Minute train bridge held by 3 screws 4000.305.
4000.305 66.		Screw
3004.223 67.		Tens indicator driving wheel Parts 2030.017.CO, 3004.223 and 3500.059 must be exchanged together. The short tooth of the tens indicator driving wheel must point to the center of the movement.
3500.059 68.		Tens jumper Parts 2030.017.CO, 3004.223 and 3500.059 must be exchanged together.
2130.142 69.		Tens jumper maintaining plate Tens jumper maintaining plate held by 2 screws 4000.306. Tensioning the spring arm.
4010.306 70.		Screw
3301.242 71.		Hour wheel (Fig.1)
3315.016 72.		Friction spring
3004.224.CO 73.		Date indicator driving wheel
3500.049 74.		Date jumper



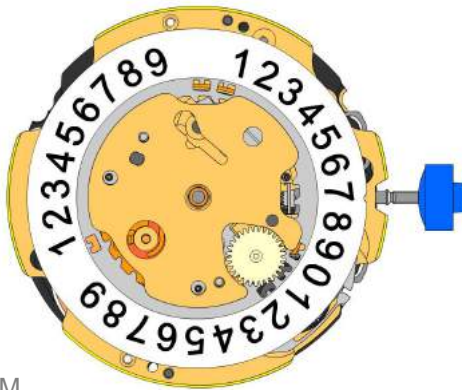



L

3504.214.AF.1.A 75.		Units indicator (standard) Nick of the indicator at 3 o'clock.
3147.054 76.		Tens intermediate wheel
2130.141 77.		Date indicator maintaining plate Date indicator maintaining plate held by 1 screw 4000.250.
4000.250 78.		Screw
3905.070 79.		Date jumper spring Insert the date jumper spring in the provided opening.





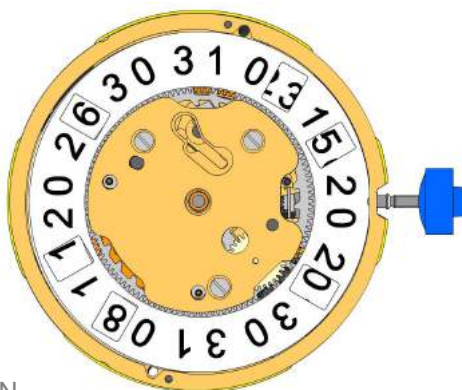

M

3504.216.AF.1.A 80.		Tens indicator (standard) Insert the date jumper spring in the previous opening.
2130.140.G 81.		Date mechanism maintaining plate Date mechanism maintaining plate held by 2 screws 4000.250.
4000.250 82.		Screw
3506.072.G 83.		Dial support



N

8200 84.		Moebius 8200
9014 85.		Moebius 9014
124 86.		Jismaa 124
9020 87.		Moebius 9020

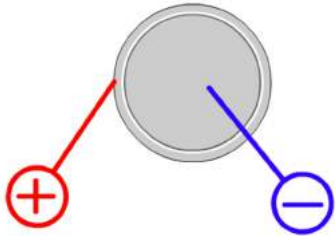

Battery	395
Voltage	1.55 V

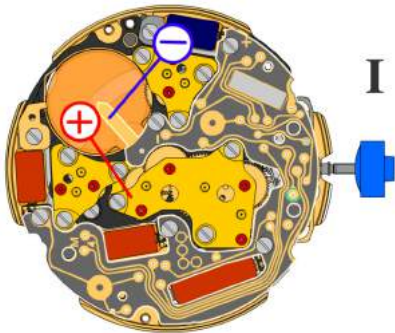

*Setting stem in position I, calendar not in gear,
60 s measuring interval for rate and consumption:*

Typical consumption	1.48 μA
Maximal consumption	1.65 μA
Rate	-10s/M. .. +20s/M.
Lower working voltage limit	1.20 V

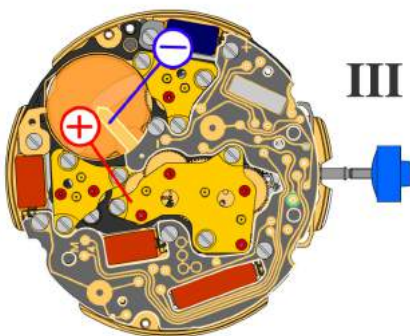

Setting stem in position III, 60 s measuring interval:

Typical consumption	0.10 μA
Maximal consumption	0.30 μA

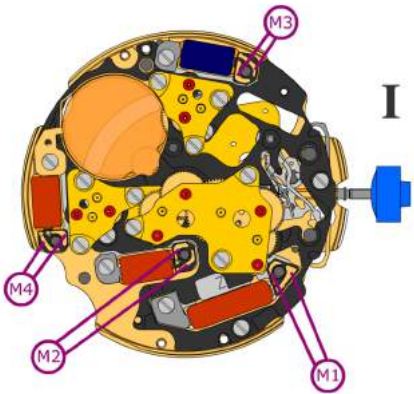

Coil resistance M1 **1.90 k Ω .. 2.10 k Ω**

Coil resistance M2 **1.68 k Ω .. 1.88 k Ω**

Coil resistance M3 **1.68 k Ω .. 1.88 k Ω**

Coil resistance M4 **1.68 k Ω .. 1.88 k Ω**

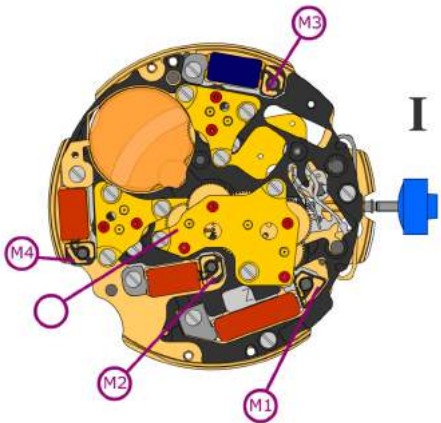

Coil isolation M1/M2/M3/M4 **∞ k Ω**

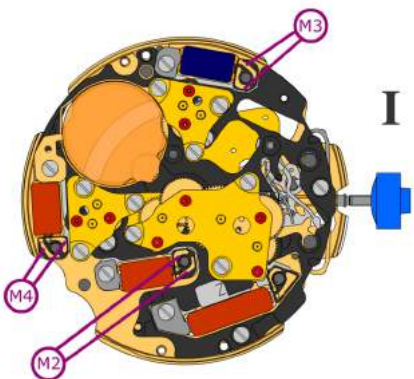

Signal generator (4.9 ms, 8 Hz):

Lower working voltage limit
M2/M3/M4 **1.20 V**

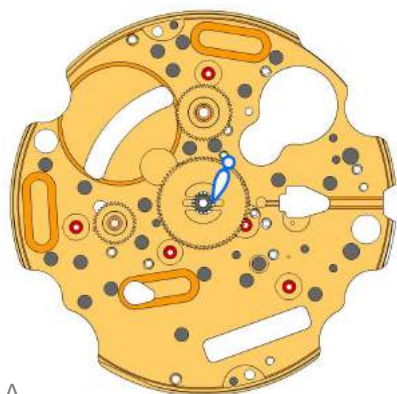

A

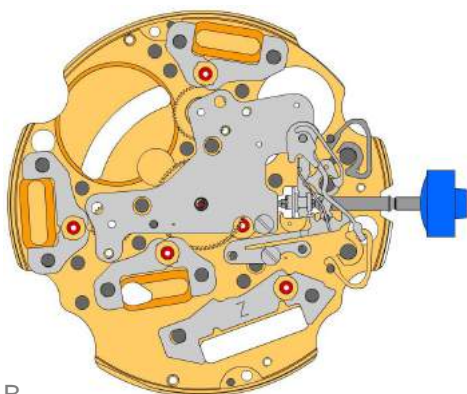



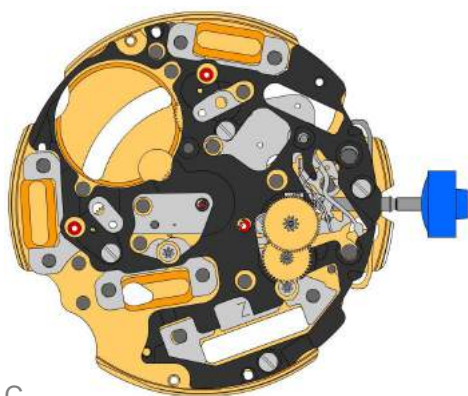

B

2000.574.G 1.		Werkplatte
3305.282.CO 2.		Minutenrohr mit Mitnehmer (Aig.2)
3301.244.CO 3.		Stundenrad (Zähler 24h) (Chrono)
3301.243.CO 4.		Stundenrad (Zähler 12h) (Alarm)

2030.017.CO 5.		Zentrumbrücke Zentrumbrücke gehalten durch 1 Schraube 4000.250. Die Teile 2030.017.CO, 3004.223 und 3500.059 sind zusammen auszutauschen.
4000.250 6.		Schraube
3001.055.FI 7.		Kupplungstrieb
3000.177.CO 8.		Stellwelle
3017.049 9.		Winkelhebel
3905.049 10.		Winkelhebelraste (3 positions) Winkelhebelraste gehalten durch 1 Schraube 4000.250.
4000.250 11.		Schraube
3015.081 12.		Wippe (3 Positionen) Die Teile 3015.081 und 3905.067 sind zusammen auszutauschen.
3905.067 13.		Wippenfeder Den Federarm spannen. Die Teile 3015.081 und 3905.067 sind zusammen auszutauschen.
3406.030 14.		Drückerraste B Graue Drückerraste zwischen den beiden Säulen auf der entfernteren Seite platzieren.
3406.038 15.		Drückerraste A Gelbe Drückerraste zwischen den beiden Säulen auf der näheren Seite platzieren.
3622.040 16.		Stator Markierung [Z] auf Stator.
3622.039 17.		Stator (Zähler 6h, 9h, Chrono)
3622.039 18.		Stator (Zähler 6h, 9h, Chrono)
3622.039 19.		Stator (Zähler 6h, 9h, Chrono)





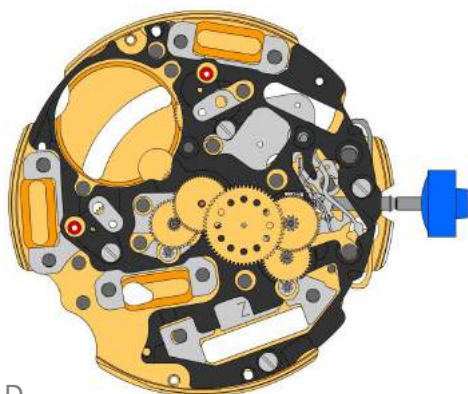

C

3603.079 20.		Kunststoffhalterung Kunststoffhalterung gehalten durch 4 Schrauben 4000.250.
4000.250 21.		Schraube
3715.094.RK 22.		Rotor
3715.094.RK 23.		Rotor







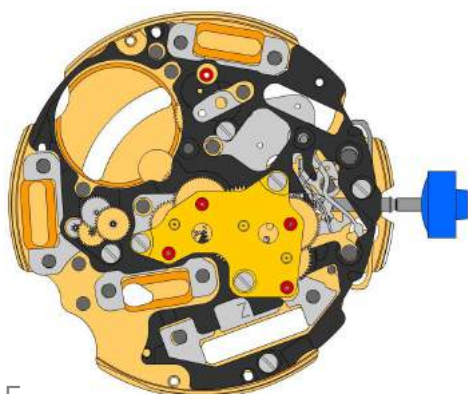

D

3147.046.CO 24.		Zwischenrad
3136.142.CO 25.		Sekundenrad (lang)
3147.047.CO 26.		Zwischenrad (Chrono)
3136.144.CO 27.		Chrono-Zentrumrad (Aig.2)
3122.056.CO 28.		Kleinbodenrad





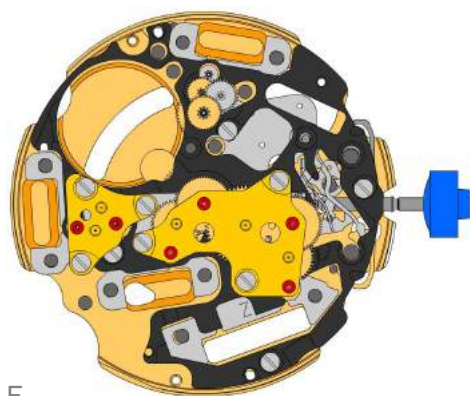

E

2020.148.G 29.		Räderwerkbrücke Räderwerkbrücke held by 3 screws 4000.250.
4000.250 30.		Schraube
3715.095.RK 31.		Rotor
3147.048.CO 32.		Zwischenrad (Zähler)
3007.056.CO 33.		Wechselrad (Zähler 24h)
3402.008.CO 34.		Minutenzählrad



F

2020.149.G 35.		Zähler-Räderwerkbrücke Zähler-Räderwerkbrücke gehalten durch 3 Schrauben 4000.250.
4000.250 36.	 T	Schraube
3715.095.RK 37.	 ↓	Rotor
3147.048.CO 38.	 +	Zwischenrad (Zähler)
3007.055.CO 39.	 ↓	Wechselrad (Zähler 12h)
3402.007.CO 40.	 ↑	Minutenzählrad

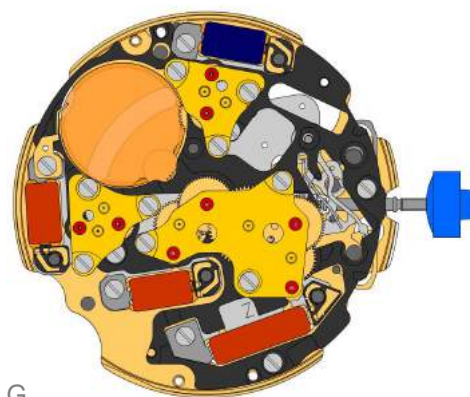

G

2020.149.G 41.		Zähler-Räderwerkbrücke Zähler-Räderwerkbrücke gehalten durch 3 Schrauben 4000.250.
4000.250 42.	 T	Schraube
3621.053.RK 43.		Spule Achtung: Spule nur am grauen Spulenkern halten. Spule gehalten durch 1 Schraube 4000.250.
3621.054.RK 44.		Spule (Zähler 9h, Chrono) Achtung: Spule nur am grauen Spulenkern halten. Spule gehalten durch 1 Schraube 4000.250.
3621.054.RK 45.		Spule (Zähler 9h, Chrono) Achtung: Spule nur am grauen Spulenkern halten. Spule gehalten durch 1 Schraube 4000.250.
3621.055.RK 46.		Spule (Zähler 6h) Achtung: Spule nur am grauen Spulenkern halten. Spule gehalten durch 1 Schraube 4000.250.
4000.250 47.	 T	Schraube

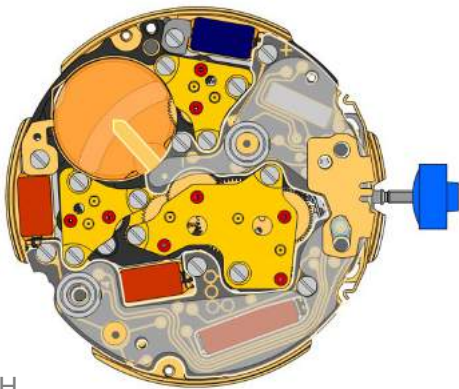

H

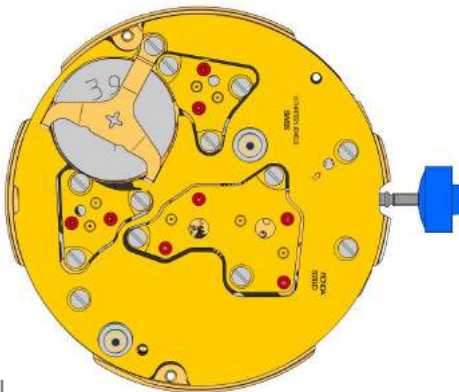

I

3601.118 48.		Kontaktbügel Kontaktbügel gehalten durch 1 Schraube 4000.250.
4000.250 49.		Schraube
3603.034 50.		Isolation für Batterie
3612.176.5130 51.		Elektronikmodul Elektronikmodul gehalten durch 5 Schrauben 4000.248. Elektronische Messungen können nun vorgenommen werden.
4000.248 52.		Schraube
3603.069 53.		Isolation für Schaltung
3603.070 54.		Isolation für Kontakt
3603.070 55.		Isolation für Kontakt
3601.107.G 56.		Drückerkontaktfeder
2130.159.G.M01.5130B 57.		Deckplatte für Elektronikmodul Deckplatte für Elektronikmodul gehalten durch 3 Schrauben 4000.250.
3600.010.HGF 58.		Batterie 395
3601.109.G 59.		Bügel + Bügel gehalten durch 1 Schraube 4000.250.
4000.250 60.		Schraube

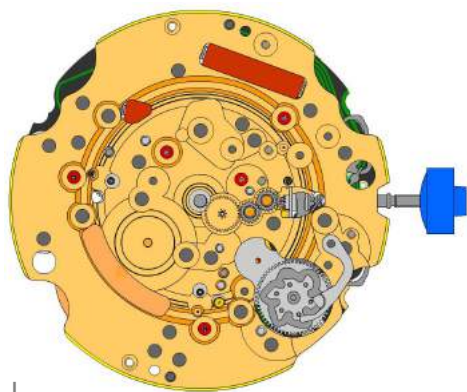

J

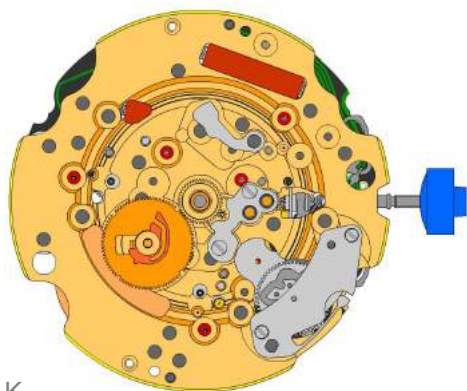

K

2000.574.G 61.		Werkplatte
3004.164 62.		Zeigerstellrad
3004.164 63.		Zeigerstellrad
3007.054.CO 64.		Wechselrad
2130.143 65.		Wechselradbrücke Wechselradbrücke gehalten durch 2 Schrauben 4000.305.
4000.305 66.		Schraube
3004.223 67.		Zehnermitnehmerrad Die Teile 2030.017.CO, 3004.223 und 3500.059 sind zusammen auszutauschen. Kurzer Zahn des Zehnermitnehmerrades in Richtung Werkszentrum positionieren.
3500.059 68.		Zehneraste Die Teile 2030.017.CO, 3004.223 und 3500.059 sind zusammen auszutauschen.
2130.142 69.		Halteplatte für Zehneraste Halteplatte für Zehneraste gehalten durch 2 Schrauben 4000.306. Den Federarm spannen.
4010.306 70.		Schraube
3301.242 71.		Stundenrad (Aig.1)
3315.016 72.		Frikionsfeder
3004.224.CO 73.		Datumanzeiger-Mitnehmerrad
3500.049 74.		Datumraste

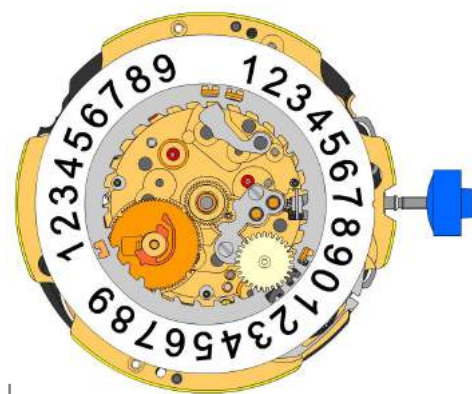

L

3504.214.AF.1.A
75.  Einer Anzeiger (Standard)
Einbuchtung im Disc bei 3 Uhr.

3147.054
76.  Zehnerzwischenrad

2130.141
77.  Halteplatte für Datumanzeige
Halteplatte für Datumanzeige gehalten durch 1 Schraube 4000.250.

4000.250
78.  Schraube

3905.070
79.  Feder für Datumraste
Feder für Datumsraste in die Öffnung einfügen.

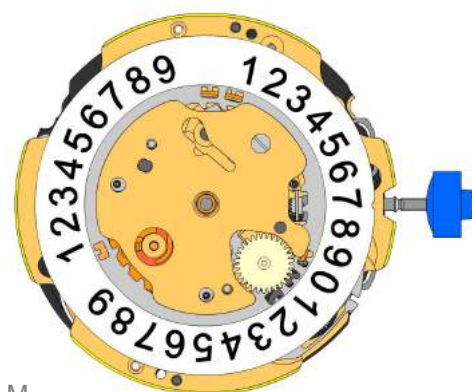

M

3504.216.AF.1.A
80.  Zehner Anzeiger (Standard)
Einbuchtung im Disc bei 3 Uhr.

2130.140.G
81.  Halteplatte für Datum-Mechanismus
Halteplatte für Datum-Mechanismus gehalten durch 2 Schrauben 4000.250.

4000.250
82.  Schraube

3506.072.G
83.  Träger für Zifferblatt

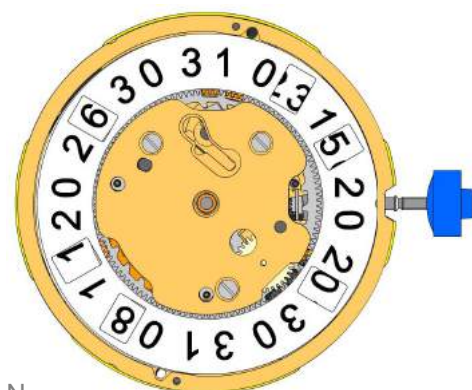

N

8200
84.  Moebius 8200

9014
85.  Moebius 9014

124
86.  Jismaa 124

9020
87.  Moebius 9020

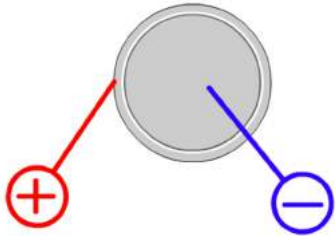

Batterie	395
Spannung	1.55 V

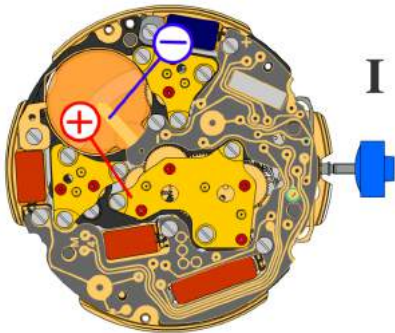

*Stellwelle in Position I, Kalender nicht im Eingriff,
60 s Messintervall für Gang und Verbrauch:*

Typischer Verbrauch	1.48 μA
Maximaler Verbrauch	1.65 μA
Gang	-10s/M. .. +20s/M.
Untere Funktionsspannungsgrenze	1.20 V

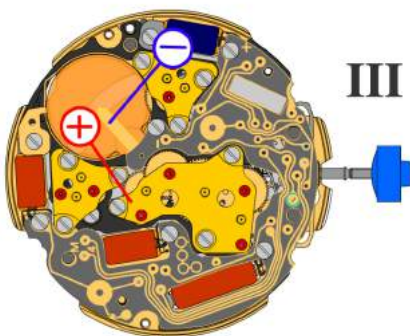

Stellwelle in Position III, 60 s Messintervall:

Typischer Verbrauch	0.10 μA
Maximaler Verbrauch	0.30 μA

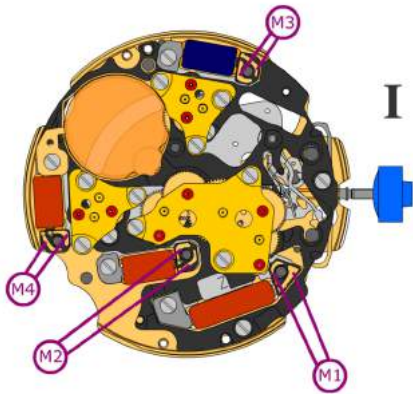

Spulenwiderstand M1 **1.90 k Ω .. 2.10 k Ω**

Spulenwiderstand M2 **1.68 k Ω .. 1.88 k Ω**

Spulenwiderstand M3 **1.68 k Ω .. 1.88 k Ω**

Spulenwiderstand M4 **1.68 k Ω .. 1.88 k Ω**

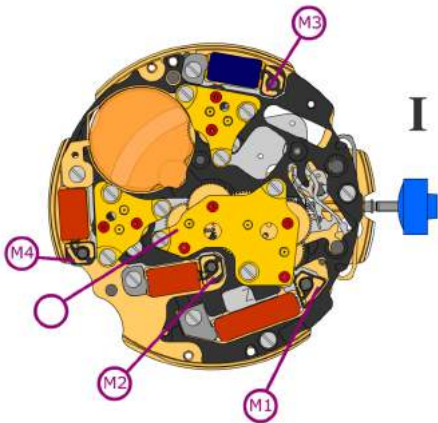

Spulenisolationen M1-M4 **∞ k Ω**

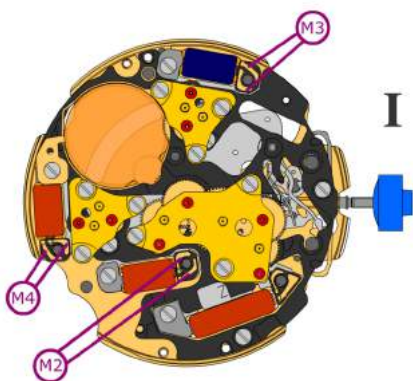

Pulsgenerator (4.9 ms, 8 Hz):

Untere Funktionsspannungsgrenzen M2-M4 **1.20 V**