

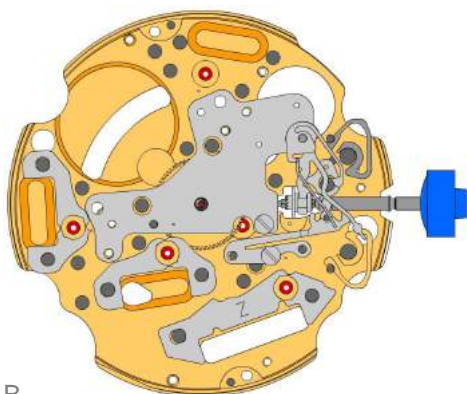



A



B

2000.574.G 1.		Platine
3305.282.CO 2.		Chaussée avec entraîneur (Aig.2)
3301.244 3.		Roue des heures (cpt 24h)

2030.017.CO 4.		<b>Pont de centre</b> Pont de centre tenue par 1 vis 4000.250. Les pièces 2030.017.CO, 3004.223 et 3500.059 doivent être échangées ensemble.
4000.250 5.		Vis
3001.055.FI 6.		Pignon coulant
3000.177.CO 7.		Tige de mise à l'heure
3017.049 8.		Tirette
3905.049 9.		<b>Sautoir de tirette (3 positions)</b> Sautoir de tirette tenue par 1 vis 4000.250.
4000.250 10.		Vis
3015.081 11.		<b>Bascule (3 positions)</b> Les pièces 3015.081 et 3905.067 doivent être échangées ensemble.
3905.067 12.		<b>Ressort de bascule</b> Mise en tension du ressort. Les pièces 3015.081 et 3905.067 doivent être échangées ensemble.
3406.030 13.		<b>Sautoir de poussoir B</b> Fixer le sautoir de poussoir gris entre les deux piliers plus loin.
3406.038 14.		<b>Sautoir de poussoir A</b> Fixer le sautoir de poussoir jaune entre les deux piliers plus proche.
3622.040 15.		<b>Stator</b> Marquage  Z  sur le stator.
3622.039 16.		<b>Stator (cpt 6h, 9h, chrono)</b>
3622.039 17.		<b>Stator (cpt 6h, 9h, chrono)</b>

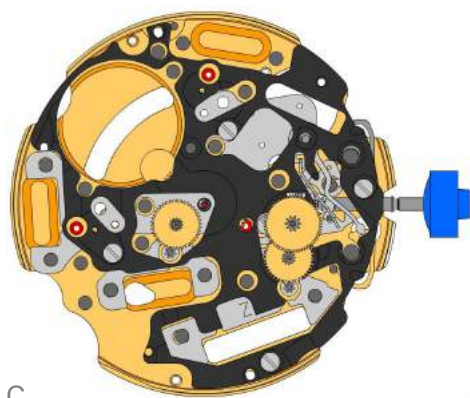
**C**

3603.079  
18.  **Potence plastique**  
Potence plastique tenue par 4 vis 4000.250.

4000.250  
19.  **Vis**

3715.094.RK  
20.  **Rotor**

3715.094.RK  
21.  **Rotor**

3147.046.CO  
22.  **Roue intermédiaire**

3136.142.CO  
23.  **Roue de seconde (longue)**

3147.047.CO  
24.  **Roue intermédiaire (chrono)**

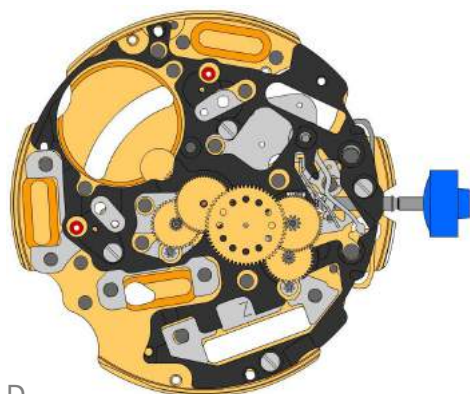
**D**

3136.144.CO  
25.  **Roue de chronographe (Aig.2)**

3122.056.CO  
26.  **Roue moyenne**

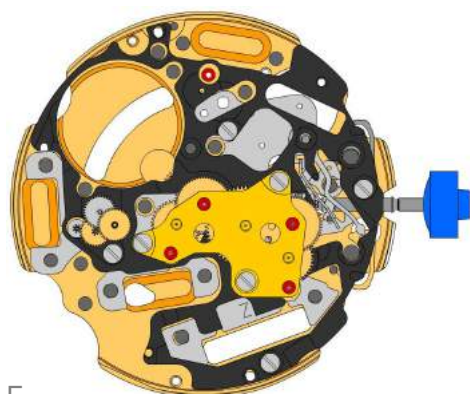

**E**

2020.148.G  
27.  **Pont de rouage**  
Pont de rouage tenue par 3 vis 4000.250.

4000.250  
28.  **Vis**









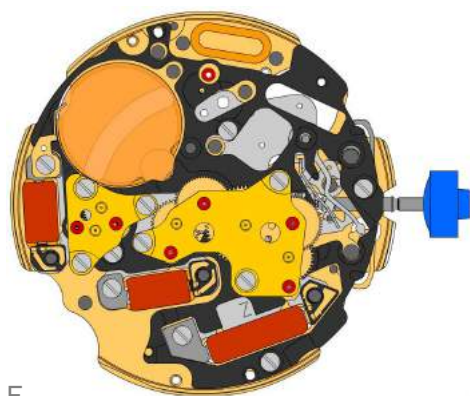
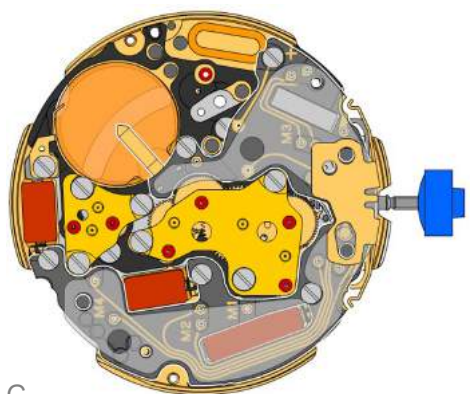
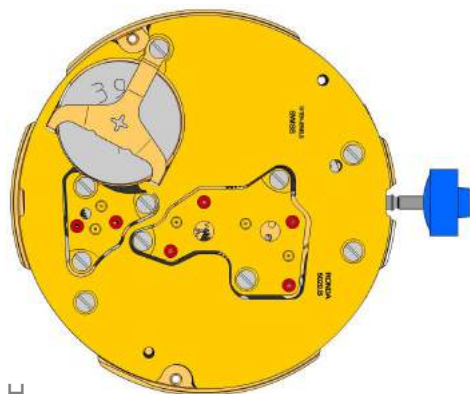







3715.095.RK  
29.  **Rotor**

3147.048.CO  
30.  **Roue intermédiaire (cpt)**









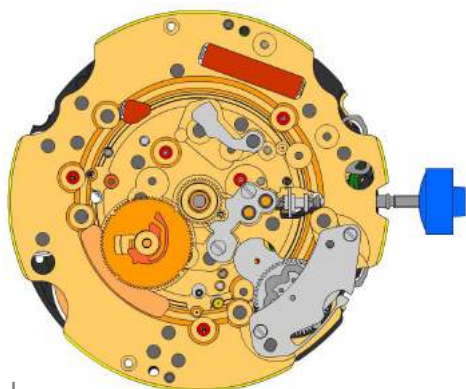
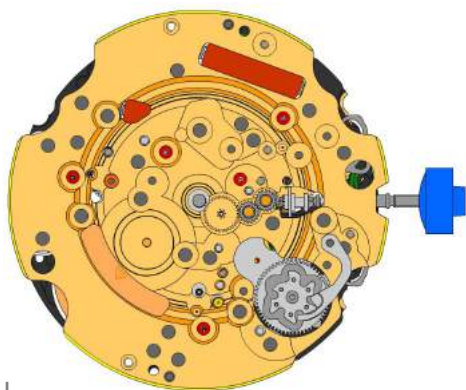





3007.056.CO  
31.  **Roue de minuterie (cpt 24h)**

3402.008.CO  
32.  **Roue compteuse de minutes (24h)**



**F**

**G**

**H**

2020.149.G 33.		<b>Pont de rouage compteur</b> Pont de rouage compteur tenue par 3 vis 4000.250.
4000.250 34.		<b>Vis</b>
3621.053.RK 35.		<b>Bobine</b> Attention: Prendre la bobine uniquement par le noyau de bobine gris. Bobine tenue par 1 vis 4000.250.
3621.054.RK 36.		<b>Bobine (cpt 9h, chrono)</b> Attention: Prendre la bobine uniquement par le noyau de bobine gris. Bobine tenue par 1 vis 4000.250.
3621.054.RK 37.		<b>Bobine (cpt 9h, chrono)</b> Attention: Prendre la bobine uniquement par le noyau de bobine gris. Bobine tenue par 1 vis 4000.250.
3601.118 38.		<b>Bride contact</b> Bride contact tenue par 1 vis 4000.250.
4000.250 39.		<b>Vis</b>
3503.054 40.		<b>Tube</b>
3603.034 41.		<b>Isolateur pile</b>
3612.144.5020 42.		<b>Module électronique</b> Module électronique tenue par 5 vis 4000.248. Les mesures électroniques peuvent être réaliser maintenant.
4000.248 43.		<b>Vis</b>
3603.069 44.		<b>Isolateur de circuit</b>
3601.107.G 45.		<b>Ressort contact pousoirs</b>
2130.138.G.M01.5020B 46.		<b>Couvre-module électronique</b> Couvre-module électronique tenue par 3 vis 4000.250.
3600.010.HGF 47.		<b>Pile 395</b>
3601.109.G 48.		<b>Bride +</b> Bride tenue par 1 vis 4000.250.
4000.250 49.		<b>Vis</b>

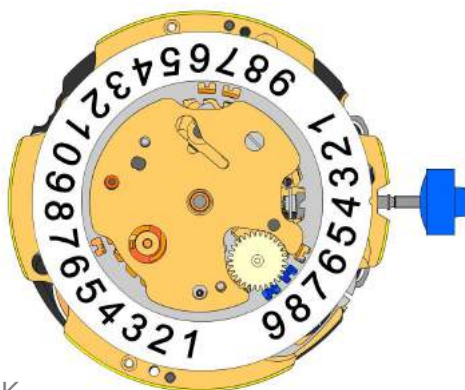

2000.574.G 50.		Platine
3004.164 51.		Renvoi
3004.164 52.		Renvoi
3007.054.CO 53.		Roue de minuterie
2130.143 54.		Pont du rouage de minuterie Pont du rouage de minuterie tenue par 2 vis 4000.305.
4000.305 55.		Vis
3004.223 56.		<b>Roue entraîneuse des dizaines</b> Les pièces 2030.017.CO, 3004.223 et 3500.059 doivent être échangées ensemble. Positionnement de la dent courte de la roue entraîneuse des dizaines en direction le centre du mouvement.
3500.059 57.		<b>Sautoir des dizaines</b> Les pièces 2030.017.CO, 3004.223 et 3500.059 doivent être échangées ensemble.
2130.142 58.		<b>Plaque de maintien du sautoir des dizaines</b> Plaque maintien sautoir des dizaines tenue par 2 vis 4000.306. Mise en tension du ressort en mettant le bras derrière du sautoir des dizaines.
4010.306 59.		Vis
3301.242 60.		Roue des heures (Aig.2)
3315.016 61.		Clinquant
3004.224.CO 62.		Roue entraîneuse de quantième
3500.049 63.		Sautoir de quantième







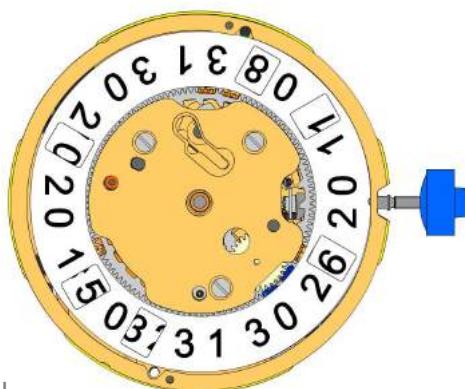

**K**

3504.214.AD.1.A 64.		<b>Indicateur des unités (standard)</b> Marquage de l'indicateur à 3 heures.
3147.054 65.		<b>Roue intermédiaire dizaines</b>
2130.141 66.		<b>Plaque de maintien de l'indicateur de quantième</b> Plaque maintien indicateur de quantième tenue par 1 vis 4000.250.
3905.070 67.		<b>Ressort sautoir de quantième</b> Insertion du ressort sautoir de quantième dans l'ouverture.

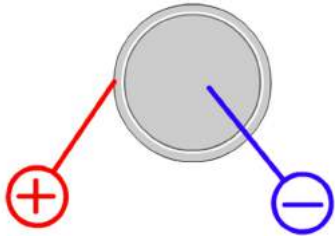

**L**

3504.215.AD.1.A 68.		<b>Indicateur des dizaines (standard)</b> Marquage de l'indicateur à 3 heures.
2130.140.G 69.		<b>Plaque de maintien du mécanisme de quantième</b> Plaque maintien mécanisme de quantième tenue par 2 vis 4000.250.
4000.250 70.		<b>Vis</b>
3506.072.G 71.		<b>Support de cadran</b>

8200 72.		<b>Moebius 8200</b>
9014 73.		<b>Moebius 9014</b>
124 74.		<b>Jismaa 124</b>
9020 75.		<b>Moebius 9020</b>

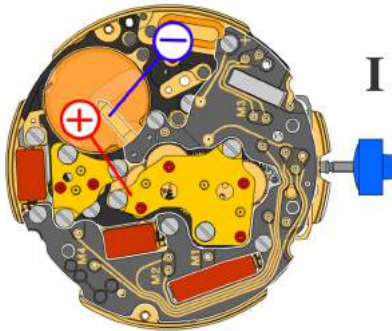

Pile	<b>395</b>
Tension	<b>1.55 V</b>



*Tige de mise à l'heure en position I, calendrier hors engrenage, intervalle de mesure 60 s pour la marche et la consommation:*

Consommation typique	<b>1.32 <math>\mu</math>A</b>
Consommation maximale	<b>1.65 <math>\mu</math>A</b>
Marche	<b>-10s/M. .. +20s/M.</b>
Limite inférieure de la tension de fonctionnement	<b>1.20 V</b>

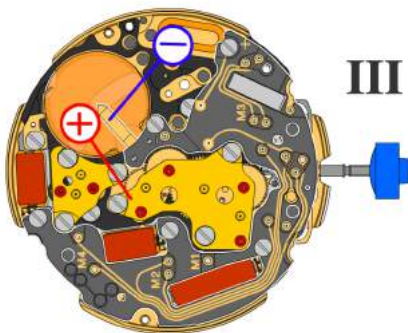

*Tige de mise à l'heure en position III, intervalle de mesure 60 s:*

Typical consumption	<b>0.10 <math>\mu</math>A</b>
Maximal consumption	<b>0.30 <math>\mu</math>A</b>

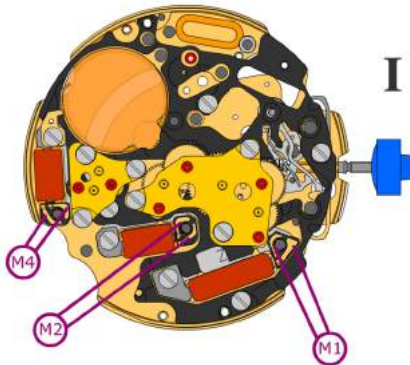

Résistance de la bobine M1      **1.90 k $\Omega$  .. 2.10 k $\Omega$**

Résistance de la bobine M2      **1.68 k $\Omega$  .. 1.88 k $\Omega$**

Résistance de la bobine M4      **1.68 k $\Omega$  .. 1.88 k $\Omega$**

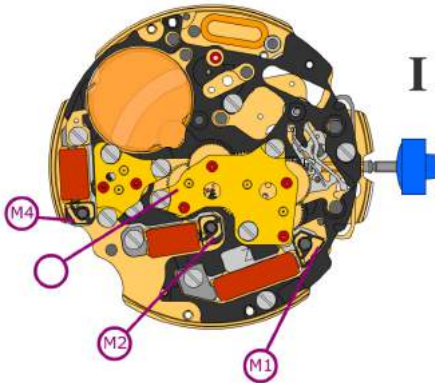

Isolation de la bobine M1/M2/M4       **$\infty$  k $\Omega$**

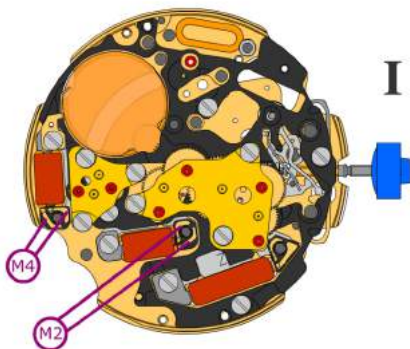

*Générateur d'impulsion*  
(4.9 ms, 8 Hz):



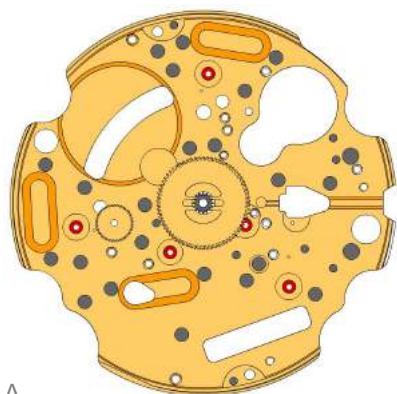



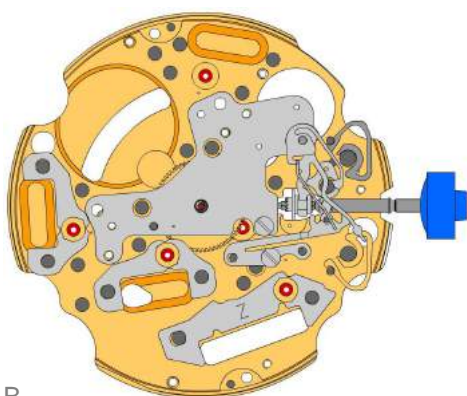









Limite inférieure de la tension de  
fonctionnement M2/M4      **1.20 V**



A









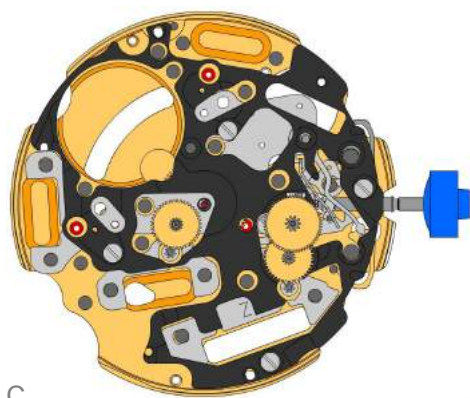
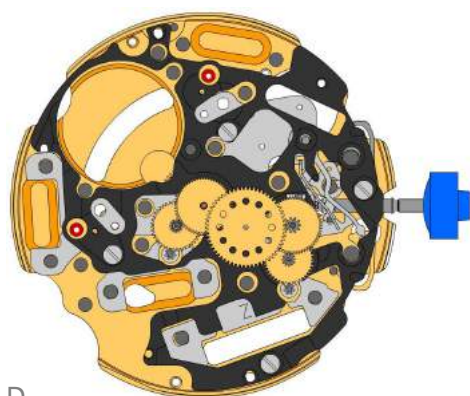
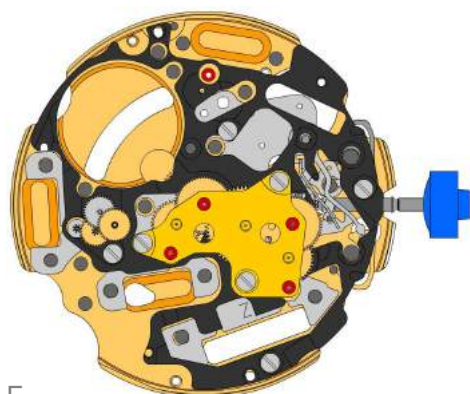







B

2000.574.G 1.		Main plate
3305.282.CO 2.		Cannon pinion with driver (Aig.2)
3301.244 3.		Hour wheel (counter 24h)
2030.017.CO 4.		Centre bridge Centre bridge held by 1 screw 4000.250. Parts 2030.017.CO, 3004.223 and 3500.059 must be exchanged together.
4000.250 5.		Screw
3001.055.FI 6.		Sliding pinion
3000.177.CO 7.		Setting stem
3017.049 8.		Setting lever
3905.049 9.		Setting lever jumper (3 positions) Setting lever jumper held by 1 screw 4000.250.
4000.250 10.		Screw
3015.081 11.		Yoke (3 positions) Parts 3015.081 and 3905.067 must be exchanged together.
3905.067 12.		Yoke spring Tensioning the spring arm. Parts 3015.081 and 3905.067 must be exchanged together.
3406.030 13.		Pusher jumper B Put the grey jumper between the two posts on the further side.
3406.038 14.		Pusher jumper A Put the yellow jumper between the two posts on the closer side.
3622.040 15.		Stator Mark [Z] on stator.
3622.039 16.		Stator (counter 6h, 9h, chrono)
3622.039 17.		Stator (counter 6h, 9h, chrono)



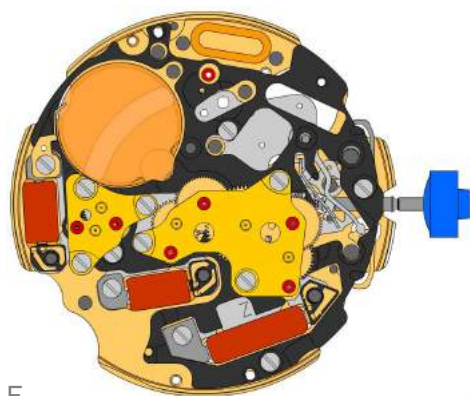

**C**

**D**

**E**

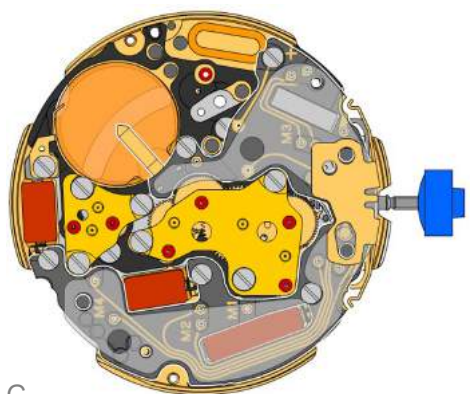
3603.079 18.		<b>Plastic bracket</b> Plastic bracket held by 4 screws 4000.250.
4000.250 19.		<b>Screw</b>
3715.094.RK 20.		<b>Rotor</b>
3715.094.RK 21.		<b>Rotor</b>
3147.046.CO 22.		<b>Intermediate wheel</b>
3136.142.CO 23.		<b>Second wheel (long)</b>
3147.047.CO 24.		<b>Intermediate wheel (chrono)</b>
3136.144.CO 25.		<b>Chronograph wheel (Aig.2)</b>
3122.056.CO 26.		<b>Third wheel</b>
2020.148.G 27.		<b>Train wheel bridge</b> Train wheel bridge held by 3 screws 4000.250.
4000.250 28.		<b>Screw</b>
3715.095.RK 29.		<b>Rotor</b>
3147.048.CO 30.		<b>Intermediate wheel (counter)</b>
3007.056.CO 31.		<b>Minute wheel (counter 24h)</b>
3402.008.CO 32.		<b>Minute counting wheel (24h)</b>









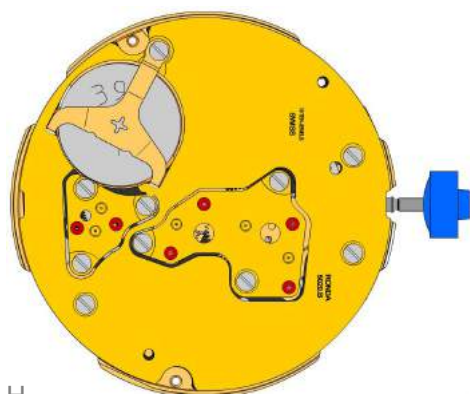









F









G

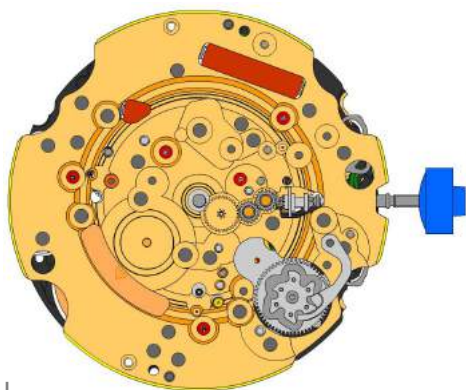



H





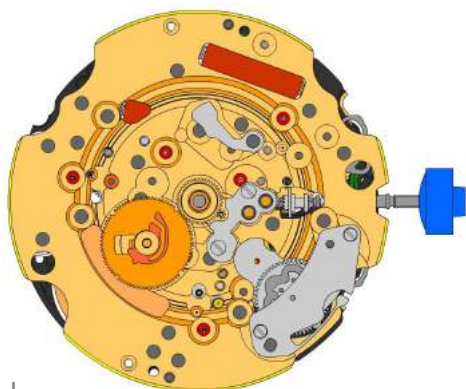

2020.149.G 33.		<b>Counter train wheel bridge</b> Counter train wheel bridge held by 3 screws 4000.250.
4000.250 34.		<b>Screw</b>
3621.053.RK 35.		<b>Coil</b> Attention: Please hold the coil only on the grey coil core. Coil held by 1 screw 4000.250.
3621.054.RK 36.		<b>Coil (counter 9h, chrono)</b> Attention: Please hold the coil only on the grey coil core. Coil held by 1 screw 4000.250.
3621.054.RK 37.		<b>Coil (counter 9h, chrono)</b> Attention: Please hold the coil only on the grey coil core. Coil held by 1 screw 4000.250.
3601.118 38.		<b>Contact strip</b> Contact strip held by 1 screw 4000.250.
4000.250 39.		<b>Screw</b>
3603.034 40.		<b>Battery insulator</b>
3503.054 41.		<b>Tube</b>
3612.144.5020 42.		<b>Electronic module</b> Electronic module tenue par 5 vis 4000.248. Electronic measurements may be realised now.
4000.248 43.		<b>Screw</b>
3603.069 44.		<b>Circuit insulator</b>
3601.107.G 45.		<b>Pusher contact spring</b>
2130.138.G.M01.5020B 46.		<b>Electronic module cover</b> Electronic module cover held by 3 screws 4000.250.
3600.010.HGF 47.		<b>Battery 395</b>
3601.109.G 48.		<b>Bridle +</b> Bridle held by 1 screw 4000.250.
4000.250 49.		<b>Screw</b>



2000.574.G 50.		Main plate
3004.164 51.		Setting wheel
3004.164 52.		Setting wheel
3007.054.CO 53.		Minute wheel
2130.143 54.		Minute train bridge Minute train bridge held by 1 screw 4000.305.
4000.305 55.		Screw



3004.223 56.		<b>Tens indicator driving wheel</b> Parts 2030.017.CO, 3004.223 and 3500.059 must be exchanged together. The short tooth of the tens indicator driving wheel must point to the center of the movement.
3500.059 57.		<b>Tens jumper</b> Parts 2030.017.CO, 3004.223 and 3500.059 must be exchanged together.

2130.142 58.		Tens jumper maintaining plate
4010.306 59.		Screw
3301.242 60.		Hour wheel (Aig.2)
3315.016 61.		Friction spring
3004.224.CO 62.		Date indicator driving wheel
3500.049 63.		Date jumper





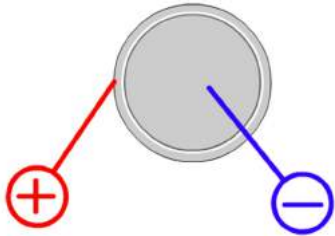

Battery	<b>395</b>
Voltage	<b>1.55 V</b>

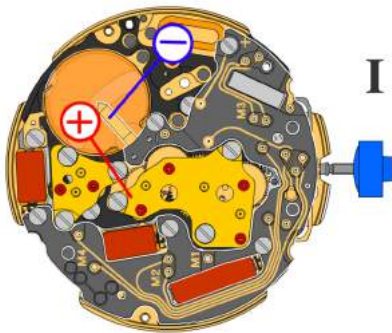

*Setting stem in position I, calendar not in gear,  
60 s measuring interval for rate and consumption:*

Typical consumption	<b>1.32 <math>\mu</math>A</b>
Maximal consumption	<b>1.65 <math>\mu</math>A</b>
Rate	<b>-10s/M. .. +20s/M.</b>
Lower working voltage limit	<b>1.20 V</b>

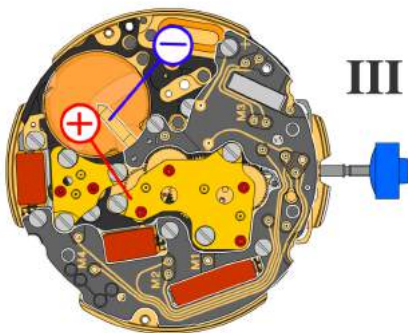

*Setting stem in position III, 60 s measuring interval:*

Typical consumption	<b>0.10 <math>\mu</math>A</b>
Maximal consumption	<b>0.30 <math>\mu</math>A</b>

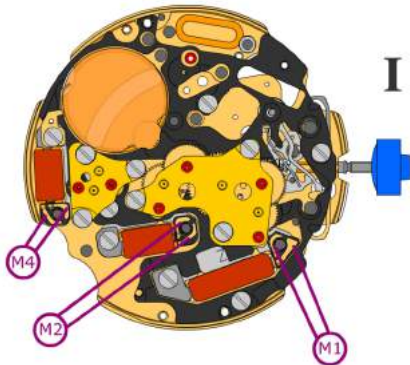

Coil resistance M1 **1.90 k $\Omega$  .. 2.10 k $\Omega$**

Coil resistance M2 **1.68 k $\Omega$  .. 1.88 k $\Omega$**

Coil resistance M4 **1.68 k $\Omega$  .. 1.88 k $\Omega$**

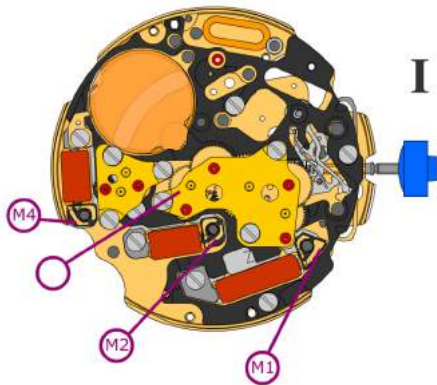

Coil isolation M1/M2/M4  **$\infty$  k $\Omega$**

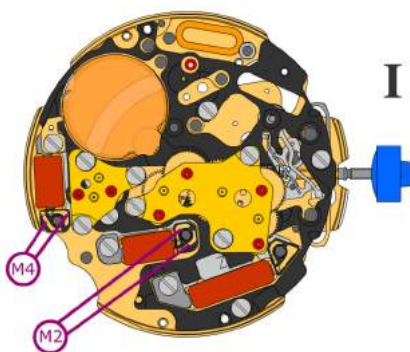

*Signal generator (4.9 ms, 8 Hz):*



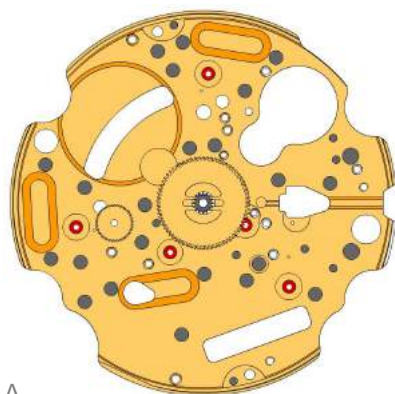



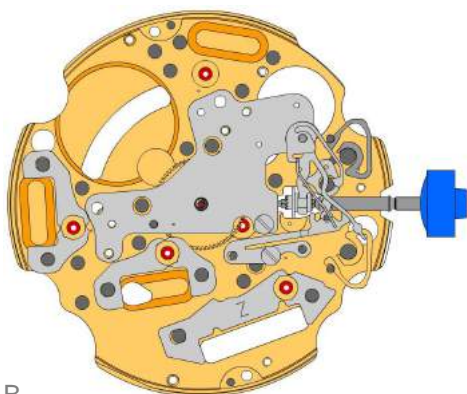









Lower working voltage limit M2/M4 **1.20 V**



A



B

2000.574.G 1.		Werkplatte
3305.282.CO 2.		Minutenrohr mit Mitnehmer (Aig.2)
3301.244 3.		Stundenrad (Zähler 24h)
2030.017.CO 4.		<b>Zentrumbrücke</b> Zentrumbrücke gehalten durch 1 Schraube 4000.250. Die Teile 2030.017.CO, 3004.223 und 3500.059 sind zusammen auszutauschen.
4000.250 5.		Schraube
3001.055.FI 6.		Kupplungstrieb
3000.177.CO 7.		Stellwelle
3017.049 8.		Winkelhebel
3905.049 9.		<b>Winkelhebelraste (3 Positionen)</b> Winkelhebelraste gehalten durch 1 Schraube 4000.250.
4000.250 10.		Schraube
3015.081 11.		<b>Wippe (3 Positionen)</b> Die Teile 3015.081 und 3905.067 sind zusammen auszutauschen.
3905.067 12.		<b>Wippenfeder</b> Den Federarm spannen. Die Teile 3015.081 und 3905.067 sind zusammen auszutauschen.
3406.030 13.		<b>Drückerraste B</b> Graue Drückerraste zwischen den beiden Säulen auf der entfernteren Seite platzieren.
3406.038 14.		<b>Drückerraste A</b> Gelbe Drückerraste zwischen den beiden Säulen auf der näheren Seite platzieren.
3622.040 15.		<b>Stator</b> Markierung [Z] auf Stator.
3622.039 16.		Stator (Zähler 6h, 9h, Chrono)
3622.039 17.		Stator (Zähler 6h, 9h, Chrono)

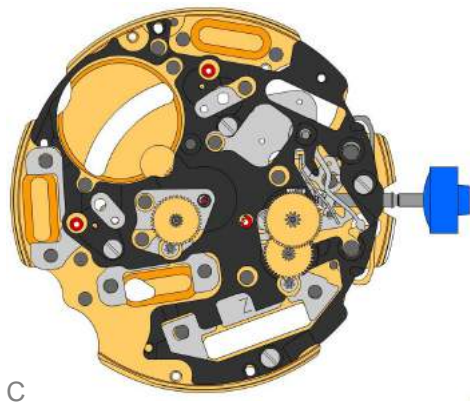



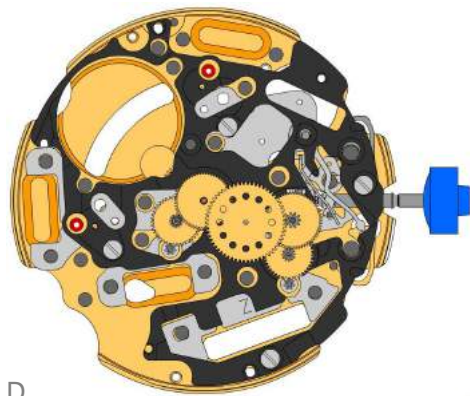



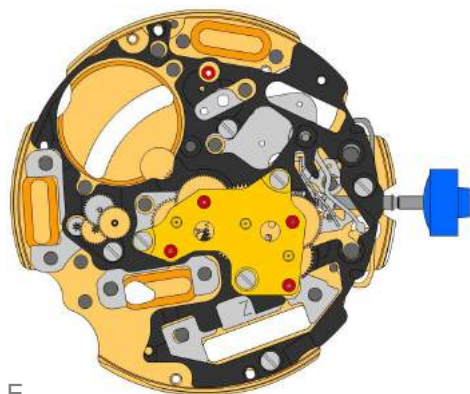





C



D



E

3603.079 18.		<b>Kunststoffhalterung</b> Kunststoffhalterung gehalten durch 4 Schrauben 4000.250.
4000.250 19.		Schraube
3715.094.RK 20.		Rotor
3715.094.RK 21.		Rotor
3147.046.CO 22.		Zwischenrad
3136.142.CO 23.		Sekundenrad (lang)
3147.047.CO 24.		Zwischenrad (Chrono)
3136.144.CO 25.		Chrono-Zentrumrad (Aig.2)
3122.056.CO 26.		Kleinbodenrad
2020.148.G 27.		<b>Räderwerkbrücke</b> Räderwerkbrücke gehalten durch 3 Schrauben 4000.250.
4000.250 28.		Schraube
3715.095.RK 29.		Rotor
3147.048.CO 30.		Zwischenrad (Zähler)
3007.056.CO 31.		Wechselrad (Zähler 24h)
3402.008.CO 32.		Minutenzählrad (24h)



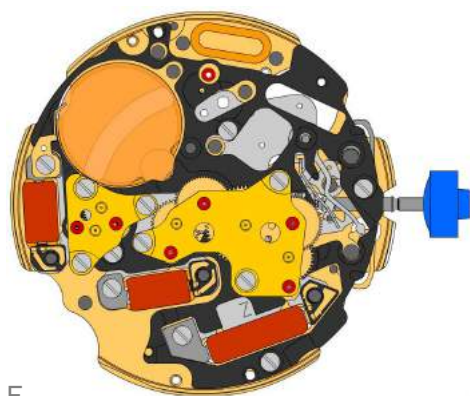

F

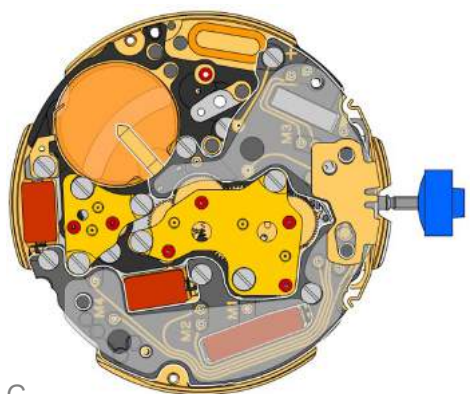



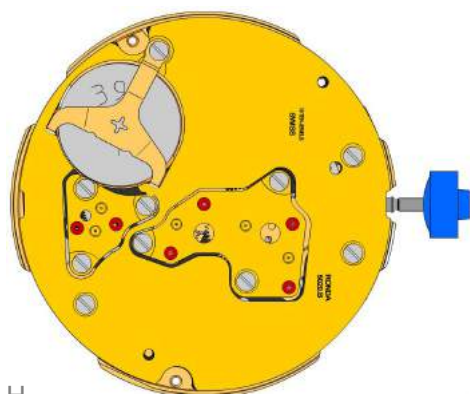





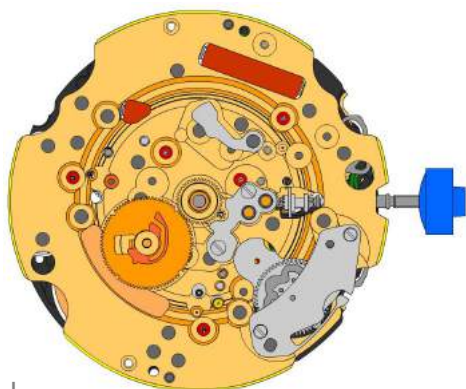
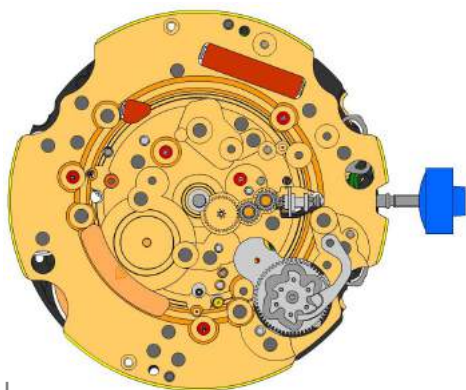





G



H

2020.149.G 33.		<b>Zähler-Räderwerkbrücke</b> Zähler-Räderwerkbrücke gehalten durch 3 Schrauben 4000.250.
4000.250 34.		<b>Schraube</b>
3621.053.RK 35.		<b>Spule</b> Achtung: Spule nur am grauen Spulenkern halten. Spule gehalten durch 1 Schraube 4000.250.
3621.054.RK 36.		<b>Spule (Zähler 9h, Chrono)</b> Achtung: Spule nur am grauen Spulenkern halten. Spule gehalten durch 1 Schraube 4000.250.
3621.054.RK 37.		<b>Spule (Zähler 9h, Chrono)</b> Achtung: Spule nur am grauen Spulenkern halten. Spule gehalten durch 1 Schraube 4000.250.
3601.118 38.		<b>Kontaktbügel</b> Kontaktbügel gehalten durch 1 Schraube 4000.250.
4000.250 39.		<b>Schraube</b>
3603.034 40.		<b>Isolation für Batterie</b>
3503.054 41.		<b>Lagerrohr</b>
3612.144.5020 42.		<b>Elektronikmodul</b> Elektronikmodul gehalten durch 5 Schrauben 4000.248. Elektronische Messungen können nun vorgenommen werden.
4000.248 43.		<b>Schraube</b>
3603.069 44.		<b>Isolation für Schaltung</b>
3601.107.G 45.		<b>Drückerkontaktfeder</b>
2130.138.G.M01.5020B 46.		<b>Deckplatte für Elektronikmodul</b> Deckplatte für Elektronikmodul gehalten durch 3 Schrauben 4000.250.
3600.010.HGF 47.		<b>Batterie 395</b>
3601.109.G 48.		<b>Bügel + Bügel gehalten durch 1 Schraube 4000.250.</b>
4000.250 49.		<b>Schraube</b>



2000.574.G 50.		Werkplatte
3004.164 51.		Zeigerstellrad
3004.164 52.		Zeigerstellrad
3007.054.CO 53.		Wechselrad
2130.143 54.		Wechselradbrücke Wechselradbrücke gehalten durch 2 Schrauben 4000.305.
4000.305 55.		Schraube
3004.223 56.		<b>Zehnermitnehmerrad</b> Die Teile 2030.017.CO, 3004.223 und 3500.059 sind zusammen auszutauschen. Kurzer Zahn des Zehnermitnehmerrades in Richtung Werkszentrum positionieren.
3500.059 57.		<b>Zehnerraste</b> Die Teile 2030.017.CO, 3004.223 und 3500.059 sind zusammen auszutauschen.
2130.142 58.		<b>Halteplatte für Zehnerraste</b> Den Federarm spannen. Halteplatte für Zehnerraste gehalten durch 2 Schrauben 4000.306.
4010.306 59.		Schraube
3301.242 60.		Stundenrad (Aig.2)
3315.016 61.		Frikionsfeder
3004.224.CO 62.		Datumanzeiger-Mitnehmerrad
3500.049 63.		Datumraste

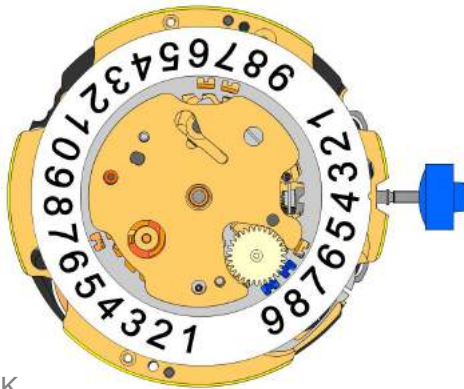

K

3504.214.AD.1.A 64.		<b>Einer Anzeiger (Standard)</b> Einbuchtung im Disc bei 3 Uhr.
3147.054 65.		<b>Zehnerzwischenrad</b>
2130.141 66.		<b>Halteplatte für Datumanzeige</b> Halteplatte für Datumanzeige gehalten durch 1 Schraube 4000.250.
3905.070 67.		<b>Feder für Datumraste</b> Feder für Datumsraste in die Öffnung einfügen.

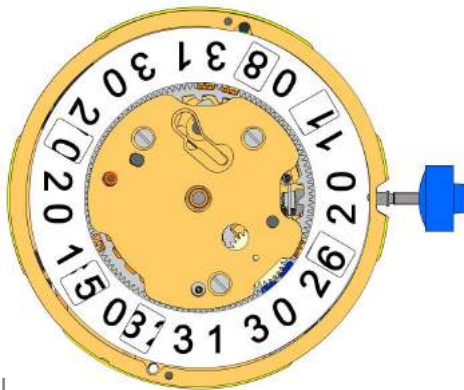

L

3504.215.AD.1.A 68.		<b>Zehner Anzeiger (Standard)</b> Einbuchtung im Disc bei 3 Uhr.
2130.140.G 69.		<b>Halteplatte für Datum-Mechanismus</b> Halteplatte für Datum-Mechanismus gehalten durch 2 Schrauben 4000.250.
4000.250 70.		<b>Schraube</b>
3506.072.G 71.		<b>Träger für Zifferblatt</b>
8200 72.		<b>Moebius 8200</b>
9014 73.		<b>Moebius 9014</b>
124 74.		<b>Jismaa 124</b>
9020 75.		<b>Moebius 9020</b>

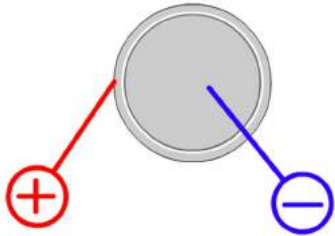

Batterie	<b>395</b>
Spannung	<b>1.55 V</b>

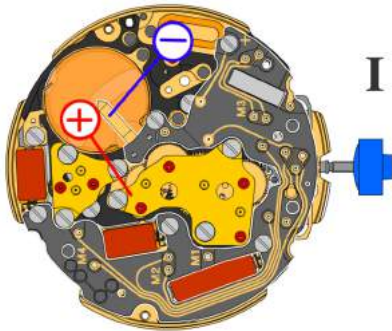

*Stellwelle in Position I, Kalender nicht im Eingriff,  
60 s Messintervall für Gang und Verbrauch:*

Typischer Verbrauch	<b>1.32 <math>\mu</math>A</b>
Maximaler Verbrauch	<b>1.65 <math>\mu</math>A</b>
Gang	<b>-10s/M. .. +20s/M.</b>
Untere Funktionsspannungsgrenze	<b>1.20 V</b>

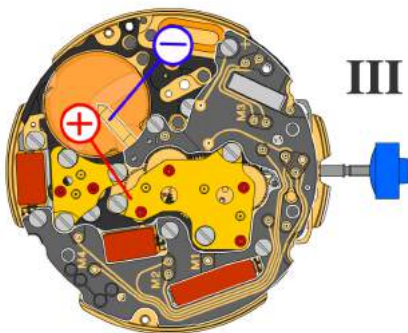

*Stellwelle in Position III, 60 s Messintervall:*

Typischer Verbrauch	<b>0.10 <math>\mu</math>A</b>
Maximaler Verbrauch	<b>0.30 <math>\mu</math>A</b>



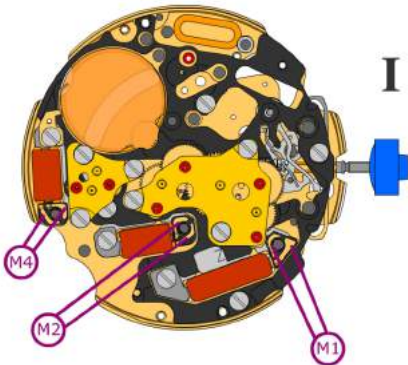

Spulenwiderstand M1 **1.90 k $\Omega$  .. 2.10 k $\Omega$**

Spulenwiderstand M2 **1.68 k $\Omega$  .. 1.88 k $\Omega$**

Spulenwiderstand M4 **1.68 k $\Omega$  .. 1.88 k $\Omega$**

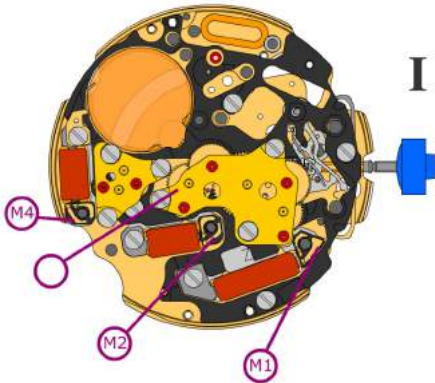

Spulenisolation M1/M2/M4  **$\infty$  k $\Omega$**

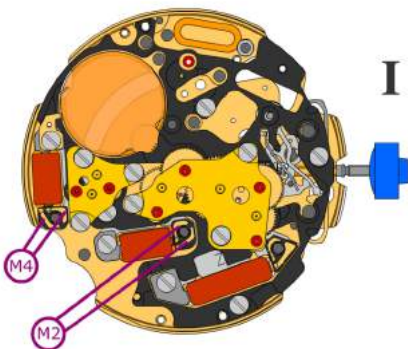

*Pulsgenerator (4.9 ms, 8 Hz):*

Untere Funktionsspannungsgrenze M2/M4 **1.20 V**