

A

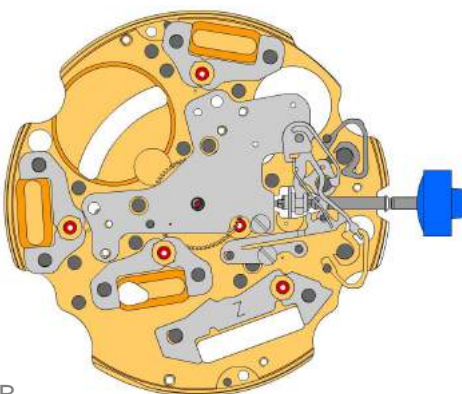

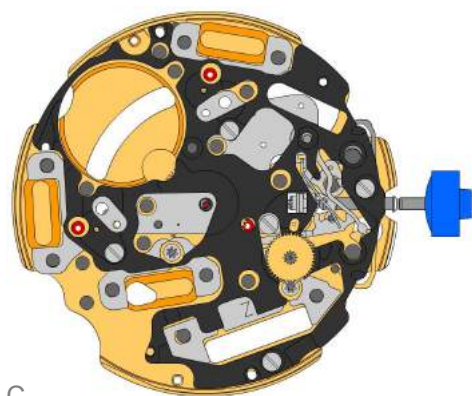



B

2000.574.G 1.		Platine
3305.282.CO 2.		Chaussée avec entraîneur (Aig.2)
3301.244 3.		Roue des heures (cpt 24h)
2030.032.CO 4.		Pont de centre Pont de centre tenue par 1 vis 4000.250.
4000.250 5.		Vis
3001.055.FI 6.		Pignon coulant
3000.177.CO 7.		Tige de mise à l'heure
3017.049 8.		Tirette
3905.049 9.		Sautoir de tirette (3 positions) Sautoir de tirette tenue par 1 vis 4000.250.
4000.250 10.		Vis
3015.081 11.		Bascule (3 positions)
3905.067 12.		Ressort de bascule Mise en tension du ressort.
3406.030 13.		Sautoir de poussoir B Fixer le sautoir de poussoir gris entre les deux piliers plus loin.
3406.038 14.		Sautoir de poussoir A Fixer le sautoir de poussoir jaune entre les deux piliers plus proche.
3622.040 15.		Stator Marquage [Z] sur le stator.
3622.039 16.		Stator (cpt 6h, 9h, chrono)
3622.039 17.		Stator (cpt 6h, 9h, chrono)
3622.039 18.		Stator (cpt 6h, 9h, chrono)

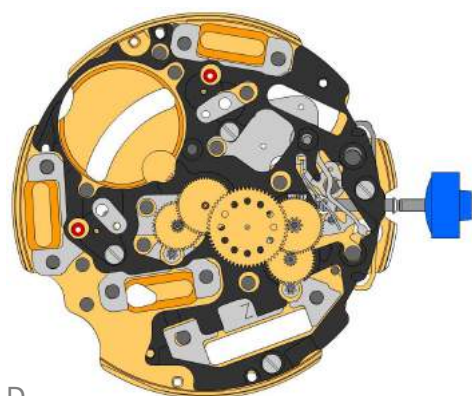



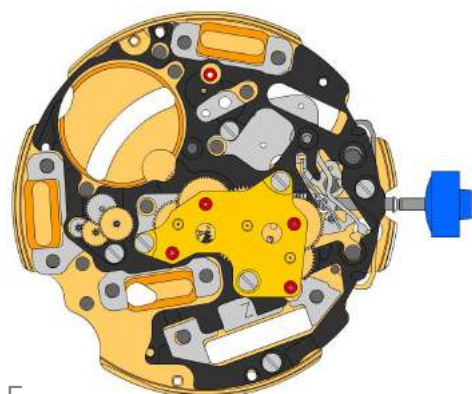

C

3603.079 19.		Potence plastique Potence plastique tenue par 4 vis 4000.250.
4000.250 20.		Vis
3715.094.RK 21.		Rotor
3715.094.RK 22.		Rotor
3147.046.CO 23.		Roue intermédiaire

D

3136.142.CO 24.		Roue de seconde (longue)
3147.047.CO 25.		Roue intermédiaire (chrono)
3136.144.CO 26.		Roue de chronographe (Aig.2)
3122.056.CO 27.		Roue moyenne

E

2020.148.G 28.		Pont de rouage Pont de rouage tenue par 3 vis 4000.250.
4000.250 29.		Vis
3715.095.RK 30.		Rotor
3147.048.CO 31.		Roue intermédiaire (cpt)
3007.056.CO 32.		Roue de minuterie (cpt 24h)
3402.008.CO 33.		Roue compteuse de minutes

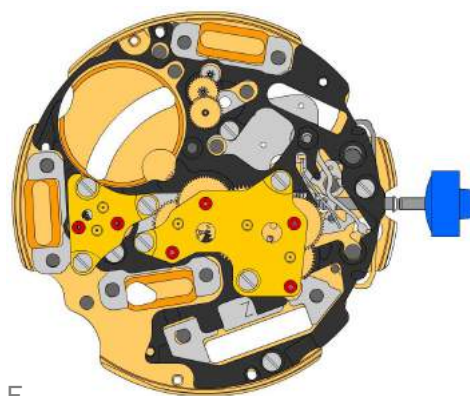
F

2020.149.G 34.		Pont de rouage compteur Pont de rouage compteur tenue par 3 vis 4000.250.
4000.250 35.		Vis
3715.095.RK 36.		Rotor
3147.053.CO 37.		Roue intermédiaire (cpt 1/10sec)
3402.016.CO 38.		Roue compteuse de 1/10 sec

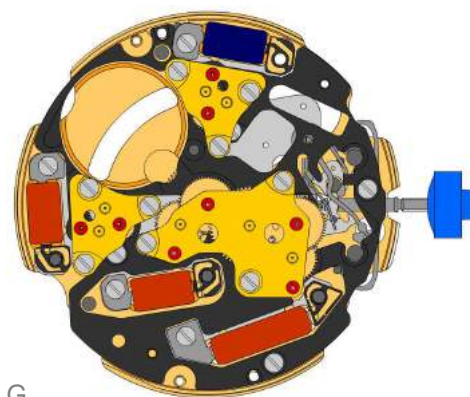

G

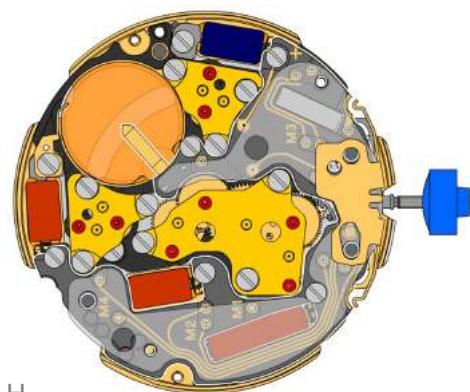
2020.149.G 39.		Pont de rouage compteur Pont de rouage compteur tenue par 3 vis 4000.250.
4000.250 40.		Vis
3621.053.RK 41.		Bobine Attention: Prendre la bobine uniquement par le noyau de bobine gris. Bobine tenue par 1 vis 4000.250.
3621.054.RK 42.		Bobine (cpt 9h, chrono) Attention: Prendre la bobine uniquement par le noyau de bobine gris. Bobine tenue par 1 vis 4000.250.
3621.054.RK 43.		Bobine (cpt 9h, chrono) Attention: Prendre la bobine uniquement par le noyau de bobine gris. Bobine tenue par 1 vis 4000.250.
3621.055.RK 44.		Bobine (cpt 6h) Attention: Prendre la bobine uniquement par le noyau de bobine gris. Bobine tenue par 1 vis 4000.250.

H

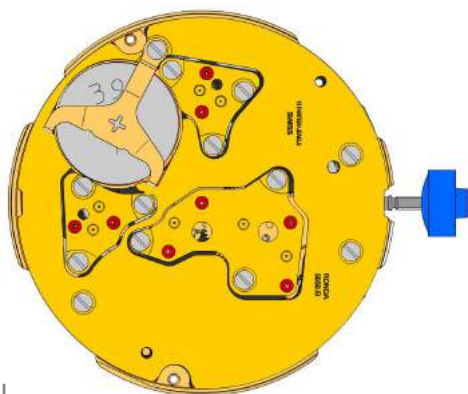
4000.250 45.		Vis
3601.118 46.		Bride contact Bride contact tenue par 1 vis 4000.250.
4000.250 47.		Vis
3603.034 48.		Isolateur pile
3612.144.5050 49.		Module électronique Module électronique tenue par 5 vis 4000.248. Les mesures électroniques peuvent être réaliser maintenant.
4000.248 50.		Vis
3603.069 51.		Isolateur de circuit
3601.107.G 52.		Ressort contact pousoirs



2130.137.G.M01.5050B
53.  **Couvre-module électronique**
Couvre-module électronique tenue par 3 vis 4000.250.

3600.010.HGF
54.  **Pile 395**

3601.109.G
55.  **Bride +**
Bride tenue par 1 vis 4000.250.

4000.250
56.  **Vis**

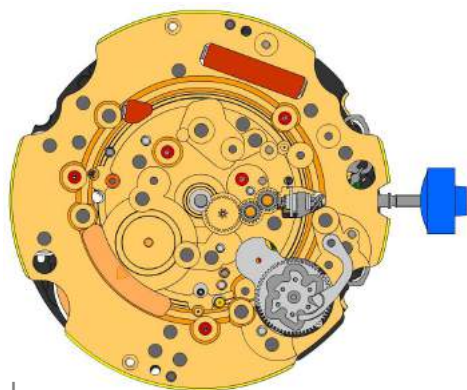





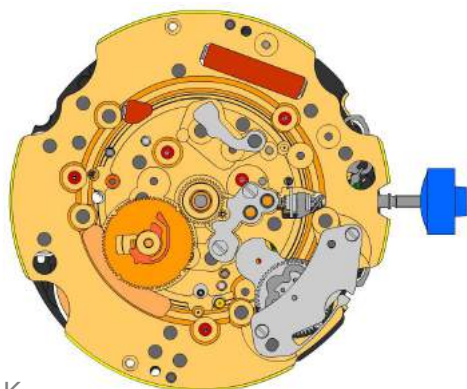





J

2000.574.G 57.		Platine
3004.164 58.		Renvoi
3004.164 59.		Renvoi
3007.054.CO 60.		Roue de minuterie



K

2130.143 61.		Pont du rouage de minuterie Pont du rouage de minuterie tenue par 1 vis 4000.305.
4000.305 62.		Vis
3004.227 63.		Roue entraîneuse des dizaines Les pièces 3004.227 et 3500.075 doivent être échangées ensemble. Positionnement de la dent courte de la roue entraîneuse des dizaines en direction le centre du mouvement.
3500.075 64.		Sautoir des dizaines Les pièces 3004.227 et 3500.075 doivent être échangées ensemble.
2130.142 65.		Plaque de maintien du sautoir des dizaines Plaque maintien sautoir des dizaines tenue par 2 vis 4000.306. Mise en tension du ressort.
4010.306 66.		Vis
3301.242 67.		Roue des heures (Aig.2)
3315.016 68.		Clinquant
3004.224.CO 69.		Roue entraîneuse de quantième
3500.049 70.		Sautoir de quantième

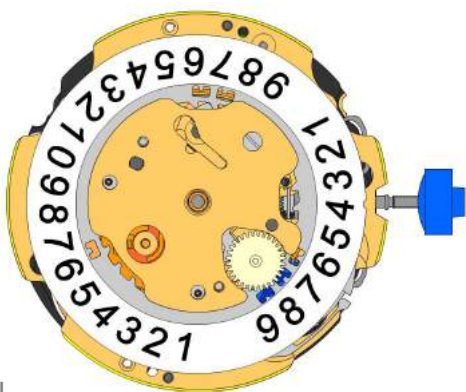



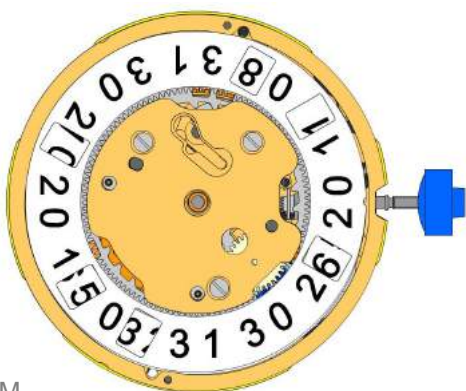

L

3504.214.AD.1.A 71.		Indicateur des unités (standard) Marquage de l'indicateur à 3 heures.
3147.054 72.		Roue intermédiaire dizaines
2130.141 73.		Plaque de maintien de l'indicateur de quantième Plaque maintien indicateur de quantième tenue par 2 vis 4000.250.
3905.070 74.		Ressort sautoir de quantième Marquage de l'indicateur à 3 heures.



M

3504.215.AD.1.A 75.		Indicateur des dizaines (standard) Marquage de l'indicateur à 3 heures.
2130.140.G 76.		Plaque de maintien du mécanisme de quantième Plaque maintien mécanisme de quantième tenue par 1 vis 4000.250.
4000.250 77.		Vis
3506.072.G 78.		Support de cadran

8200 79.		Moebius 8200
9014 80.		Moebius 9014
124 81.		Jismaa 124
9020 82.		Moebius 9020

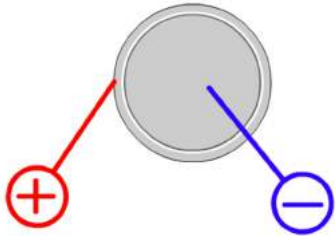

Pile	395
Tension	1.55 V

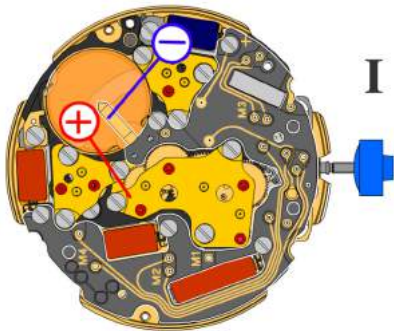

Tige de mise à l'heure en position I, calendrier hors engrenage, intervalle de mesure 60 s pour la marche et la consommation:

Consommation typique	1.32 μA
Consommation maximale	1.65 μA
Marche	-10s/M. .. +20s/M.
Limite inférieure de la tension de fonctionnement	1.20 V

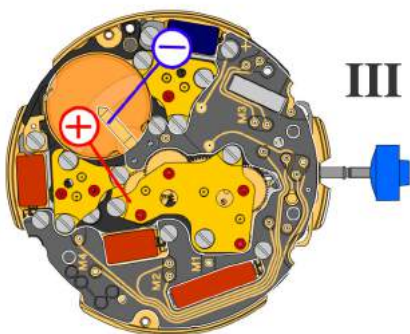

Setting stem in position III, 60 s measuring interval:

Typical consumption	0.10 μA
Maximal consumption	0.30 μA

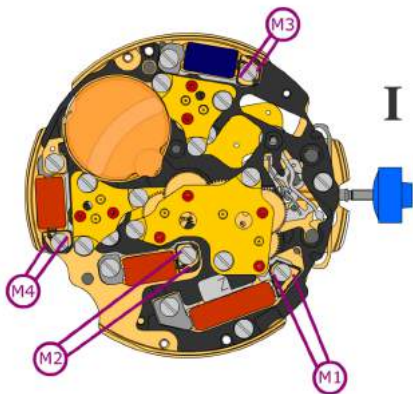

Résistance de la bobine M1 **1.90 kΩ .. 2.10 kΩ**

Résistance de la bobine M2 **1.68 kΩ .. 1.88 kΩ**

Résistance de la bobine M3 **1.68 kΩ .. 1.88 kΩ**

Résistance de la bobine M4 **1.68 kΩ .. 1.88 kΩ**

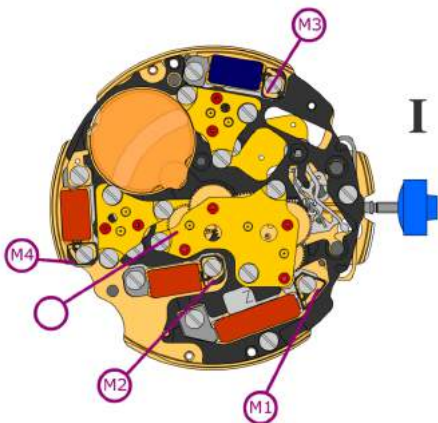

Isolation de la bobine
M1/M2/M3/M4 **∞ kΩ**

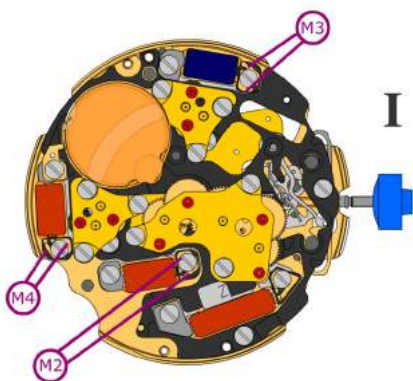

Générateur d'impulsion
(4.9 ms, 8 Hz):



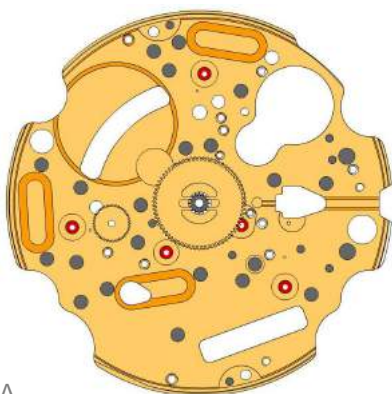



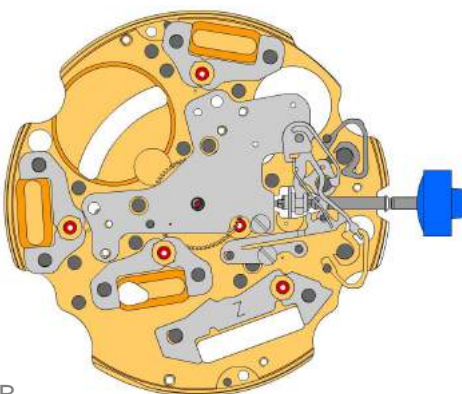











Limite inférieure de la tension de
fonctionnement M2/M3/M4 **1.20 V**









A

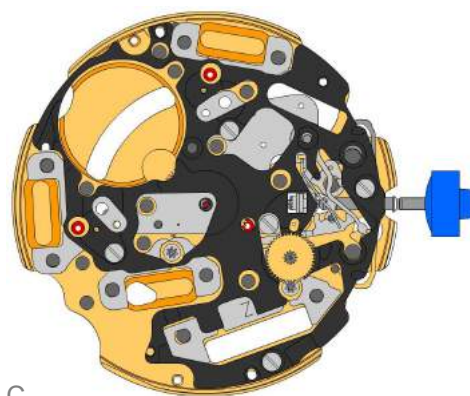





B

2000.574.G 1.		Main plate
3305.282.CO 2.		Cannon pinion with driver (Aig.2)
3301.244 3.		Hour wheel (counter 24h)
2030.032.CO 4.		Centre bridge Centre bridge held by 1 screw 4000.250.
4000.250 5.		Screw
3001.055.FI 6.		Sliding pinion
3000.177.CO 7.		Setting stem
3017.049 8.		Setting lever
3905.049 9.		Setting lever jumper (3 positions) Setting lever jumper held by 1 screw 4000.250.
4000.250 10.		Screw
3015.081 11.		Yoke (3 positions)
3905.067 12.		Yoke spring Tensioning the spring arm.
3406.030 13.		Pusher jumper B Put the grey jumper between the two posts on the further side.
3406.038 14.		Pusher jumper A Put the yellow jumper between the two posts on the closer side.
3622.040 15.		Stator Mark Z on stator.
3622.039 16.		Stator (counter 6h, 9h, chrono)
3622.039 17.		Stator (counter 6h, 9h, chrono)
3622.039 18.		Stator (counter 6h, 9h, chrono)

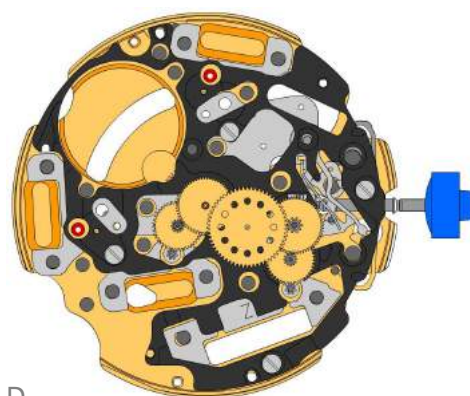



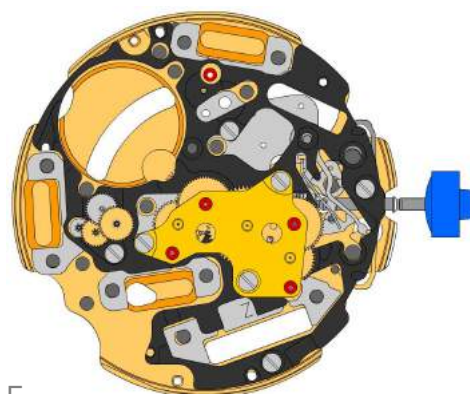

C

3603.079 19.		Plastic bracket Plastic bracket held by 4 screws 4000.250.
4000.250 20.		Screw
3715.094.RK 21.		Rotor
3715.094.RK 22.		Rotor
3147.046.CO 23.		Intermediate wheel





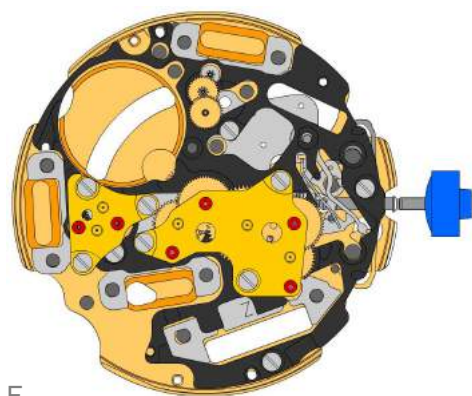

D

3136.142.CO 24.		Second wheel (long)
3147.047.CO 25.		Intermediate wheel (chrono)
3136.144.CO 26.		Chronograph wheel (Aig.2)
3122.056.CO 27.		Third wheel





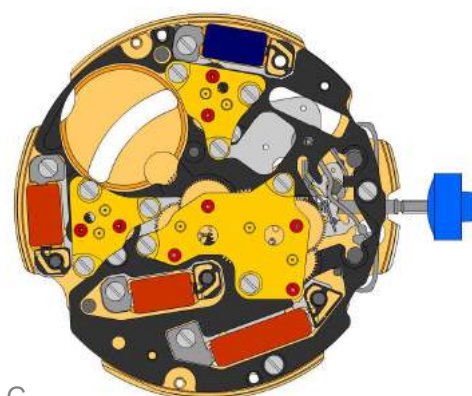

E

2020.148.G 28.		Train wheel bridge Train wheel bridge held by 3 screws 4000.250.
4000.250 29.		Screw
3715.095.RK 30.		Rotor
3147.048.CO 31.		Intermediate wheel (counter)
3007.056.CO 32.		Minute wheel (counter 24h)
3402.008.CO 33.		Minute counting wheel







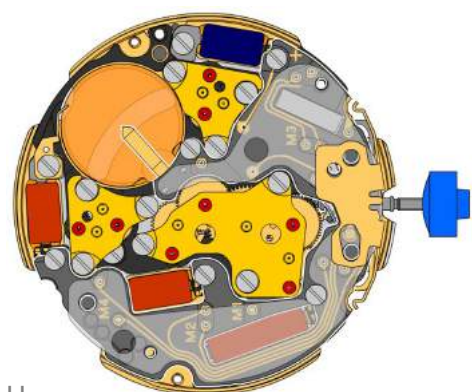

F

2020.149.G 34.		Counter train wheel bridge Counter train wheel bridge held by 3 screws 4000.250.
4000.250 35.		Screw
3715.095.RK 36.		Rotor
3147.053.CO 37.		Intermediate wheel (counter 1/10sec)
3402.016.CO 38.		Counting wheel 1/10 sec

G

2020.149.G 39.		Counter train wheel bridge Counter train wheel bridge held by 3 screws 4000.250.
4000.250 40.		Screw
3621.053.RK 41.		Coil Attention: Please hold the coil only on the grey coil core. Coil held by 1 screw 4000.250.
3621.054.RK 42.		Coil (counter 9h, chrono) Attention: Please hold the coil only on the grey coil core. Coil held by 1 screw 4000.250.
3621.054.RK 43.		Coil (counter 9h, chrono) Attention: Please hold the coil only on the grey coil core. Coil held by 1 screw 4000.250.
3621.055.RK 44.		Coil (counter 6h) Attention: Please hold the coil only on the grey coil core. Coil held by 1 screw 4000.250.

H

4000.250 45.		Screw
3601.118 46.		Contact strip Contact strip held by 1 screw 4000.250.
4000.250 47.		Screw
3603.034 48.		Battery insulator
3612.144.5050 49.		Electronic module Electronic module held by 5 screws 4000.248. Electronic measurements may be realised now.
4000.248 50.		Screw
3603.069 51.		Circuit insulator
3601.107.G 52.		Pusher contact spring

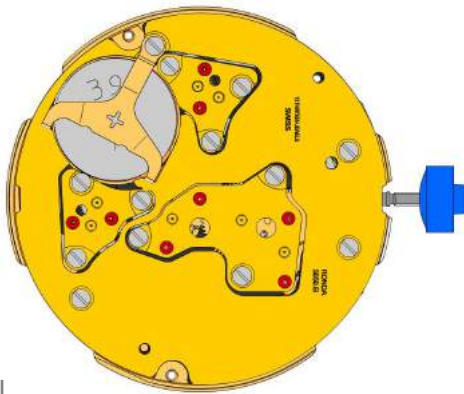





2130.137.G.M01.5050B
53.  **Electronic module cover**
Electronic module cover held by 3 screws 4000.250.

3600.010.HGF
54.  **Battery 395**

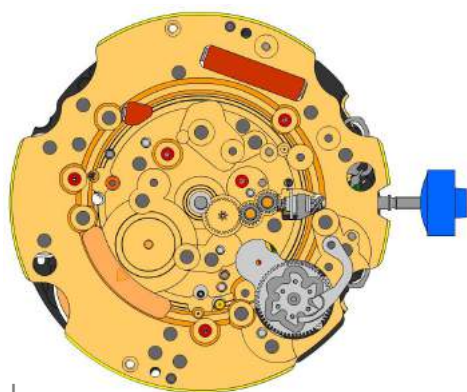







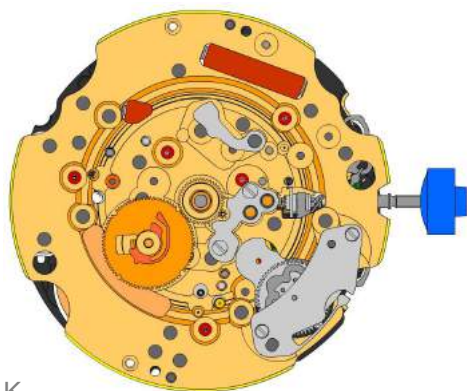

3601.109.G
55.  **Bridge +**
Bridle held by screw 4000.250.

4000.250
56.  **Screw**

J

2000.574.G 57.		Main plate
3004.164 58.		Setting wheel
3004.164 59.		Setting wheel
3007.054.CO 60.		Minute wheel

K



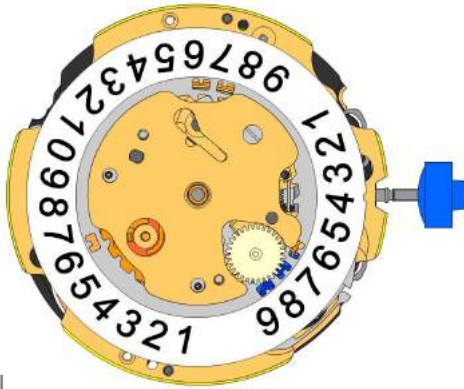

2130.143 61.		Minute train bridge Minute train bridge held by 2 screws 4000.305.
4000.305 62.		Screw
3004.227 63.		Tens indicator driving wheel Parts 3004.227 and 3500.075 must be exchanged together. The short tooth of the tens indicator driving wheel must point to the center of the movement.
3500.075 64.		Tens jumper Parts 3004.227 and 3500.075 must be exchanged together.
2130.142 65.		Tens jumper maintaining plate Tens jumper maintaining plate held by 2 screws 4000.306. Tensioning the spring arm.
4010.306 66.		Screw
3301.242 67.		Hour wheel (Fig.2)
3315.016 68.		Friction spring
3004.224.CO 69.		Date indicator driving wheel
3500.049 70.		Date jumper

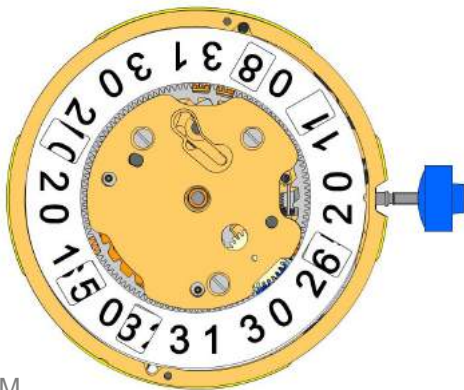









L



M

3504.214.AD.1.A 71.		Units indicator (standard) Nick of the indicator at 3 o'clock.
3147.054 72.		Tens intermediate wheel
2130.141 73.		Date indicator maintaining plate Date indicator maintaining plate held by 1 screw 4000.250.
3905.070 74.		Date jumper spring Insert the date jumper spring in the provided opening.

3504.215.AD.1.A 75.		Tens indicator (standard) Nick of the indicator at 3 o'clock.
2130.140.G 76.		Date mechanism maintaining plate Date mechanism maintaining plate held by 2 screws 4000.250.
4000.250 77.		Screw
3506.072.G 78.		Dial support

8200 79.		Moebius 8200
9014 80.		Moebius 9014
124 81.		Jismaa 124
9020 82.		Moebius 9020

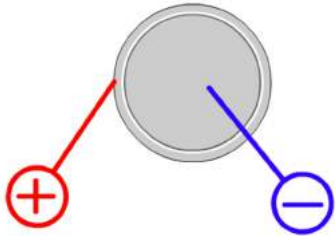

Battery	395
Voltage	1.55 V

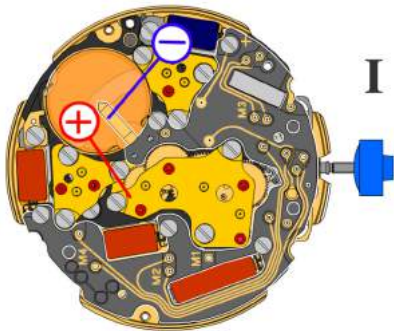

*Setting stem in position I, calendar not in gear,
60 s measuring interval for rate and consumption:*

Typical consumption	1.32 μA
Maximal consumption	1.65 μA
Rate	-10s/M. .. +20s/M.
Lower working voltage limit	1.20 V

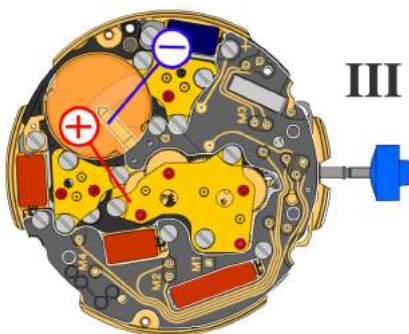

Setting stem in position III, 60 s measuring interval:

Typical consumption	0.10 μA
Maximal consumption	0.30 μA

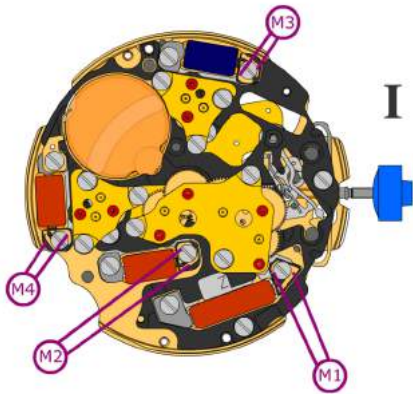

Coil resistance M1 **1.90 k Ω .. 2.10 k Ω**

Coil resistance M2 **1.68 k Ω .. 1.88 k Ω**

Coil resistance M3 **1.68 k Ω .. 1.88 k Ω**

Coil resistance M4 **1.68 k Ω .. 1.88 k Ω**

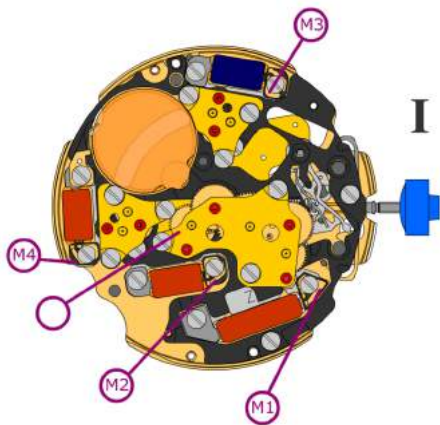

Coil isolation M1/M2/M3/M4 **∞ k Ω**

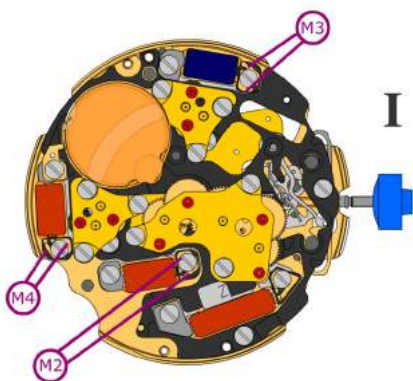

Signal generator (4.9 ms, 8 Hz):



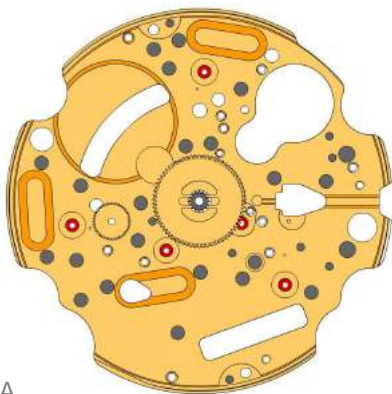



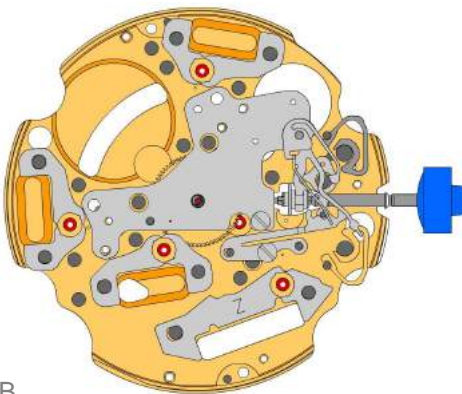











Lower working voltage limit
M2/M3/M4 **1.20 V**



A



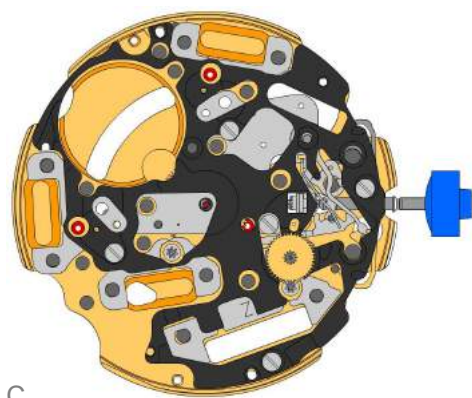

B

2000.574.G 1.		Werkplatte
3305.282.CO 2.		Minutenrohr mit Mitnehmer (Aig.2)
3301.244 3.		Stundenrad (Zähler 24h)
2030.032.CO 4.		Zentrumbrücke Zentrumbrücke gehalten durch 1 Schraube 4000.250.
4000.250 5.		Schraube
3001.055.FI 6.		Kupplungstrieb
3000.177.CO 7.		Stellwelle
3017.049 8.		Winkelhebel
3905.049 9.		Winkelhebelraste (3 Positionen) Winkelhebelraste gehalten durch 1 Schraube 4000.250.
4000.250 10.		Schraube
3015.081 11.		Wippe (3 Positionen)
3905.067 12.		Wippenfeder Den Federarm spannen.
3406.030 13.		Drückerraste B Graue Drückerraste zwischen den beiden Säulen auf der entfernteren Seite platzieren.
3406.038 14.		Drückerraste A Gelbe Drückerraste zwischen den beiden Säulen auf der näheren Seite platzieren.
3622.040 15.		Stator Markierung [Z] auf Stator.
3622.039 16.		Stator (Zähler 6h, 9h, Chrono)
3622.039 17.		Stator (Zähler 6h, 9h, Chrono)
3622.039 18.		Stator (Zähler 6h, 9h, Chrono)



C

3603.079 19.		Kunststoffhalterung Kunststoffhalterung gehalten durch 4 Schrauben 4000.250.
4000.250 20.		Schraube
3715.094.RK 21.		Rotor
3715.094.RK 22.		Rotor
3147.046.CO 23.		Zwischenrad

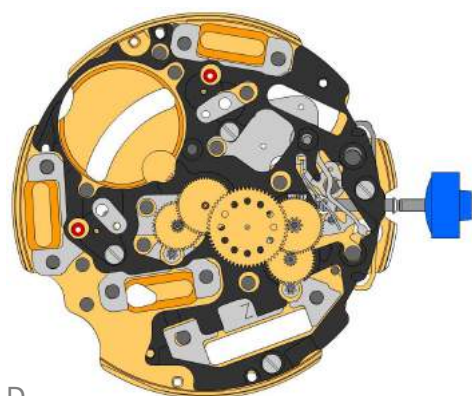

D

3136.142.CO 24.		Sekundenrad (lang)
3147.047.CO 25.		Zwischenrad (Chrono)
3136.144.CO 26.		Chrono-Zentrumrad (Aig.2)
3122.056.CO 27.		Kleinbodenrad

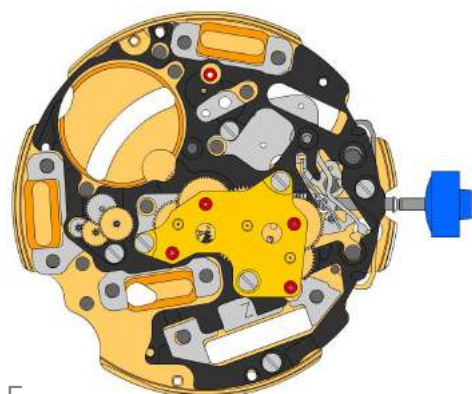



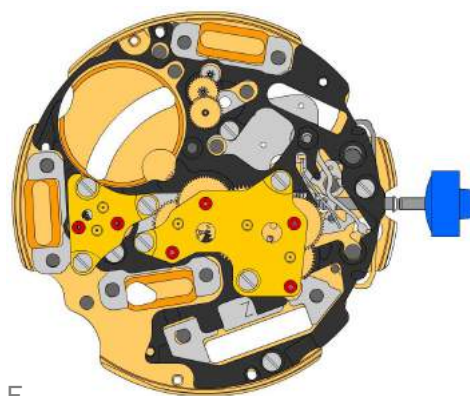

E

2020.148.G 28.		Räderwerkbrücke Räderwerkbrücke gehalten durch 3 Schrauben 4000.250.
4000.250 29.		Schraube
3715.095.RK 30.		Rotor
3147.048.CO 31.		Zwischenrad (Zähler)
3007.056.CO 32.		Wechselrad (Zähler 24h)
3402.008.CO 33.		Minutenzählrad





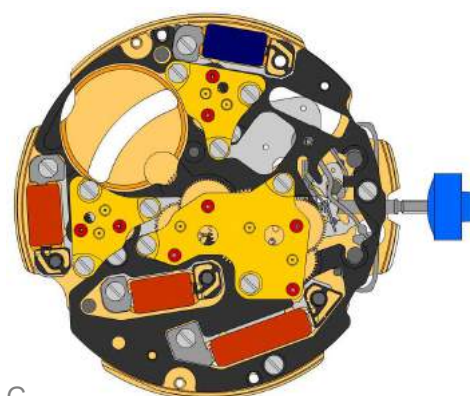

F

2020.149.G 34.		Zähler-Räderwerkbrücke Zähler-Räderwerkbrücke gehalten durch 3 Schrauben 4000.250.
4000.250 35.		Schraube
3715.095.RK 36.		Rotor
3147.053.CO 37.		Zwischenrad (Zähler 1/10sek)
3402.016.CO 38.		Zählrad 1/10 sek



G



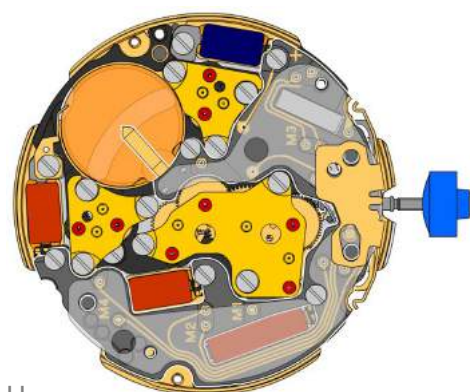

2020.149.G 39.		Zähler-Räderwerkbrücke Zähler-Räderwerkbrücke gehalten durch 3 Schrauben 4000.250.
4000.250 40.		Schraube
3621.053.RK 41.		Spule Achtung: Spule nur am grauen Spulenkern halten. Spule gehalten durch 1 Schraube 4000.250.
3621.054.RK 42.		Spule (Zähler 9h, Chrono) Achtung: Spule nur am grauen Spulenkern halten. Spule gehalten durch 1 Schraube 4000.250.
3621.054.RK 43.		Spule (Zähler 9h, Chrono) Achtung: Spule nur am grauen Spulenkern halten. Spule gehalten durch 1 Schraube 4000.250.
3621.055.RK 44.		Spule (Zähler 6h) Achtung: Spule nur am grauen Spulenkern halten. Spule gehalten durch 1 Schraube 4000.250.
4000.250 45.		Schraube
3601.118 46.		Kontaktbügel Kontaktbügel gehalten durch 1 Schraube 4000.250.
4000.250 47.		Schraube
3603.034 48.		Isolation für Batterie

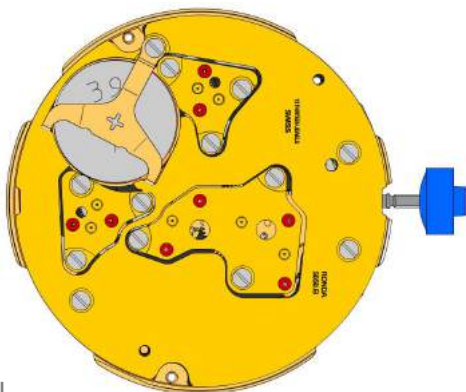

H

3612.144.5050 49.		Elektronikmodul Elektronikmodul gehalten durch 5 Schrauben 4000.248. Elektronische Messungen können nun vorgenommen werden.
4000.248 50.		Schraube
3603.069 51.		Isolation für Schaltung
3601.107.G 52.		Drückerkontaktfeder



2130.137.G.M01.5050B 53.		Deckplatte für Elektronikmodul Deckplatte für Elektronikmodul gehalten durch 3 Schrauben 4000.250.
3600.010.HGF 54.		Batterie 395
3601.109.G 55.		Bügel + Bügel gehalten durch 1 Schraube 4000.250.
4000.250 56.		Schraube

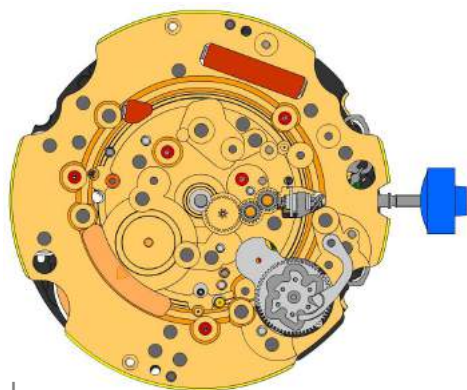

J

2000.574.G 57.		Werkplatte
3004.164 58.		Zeigerstellrad
3004.164 59.		Zeigerstellrad
3007.054.CO 60.		Wechselrad

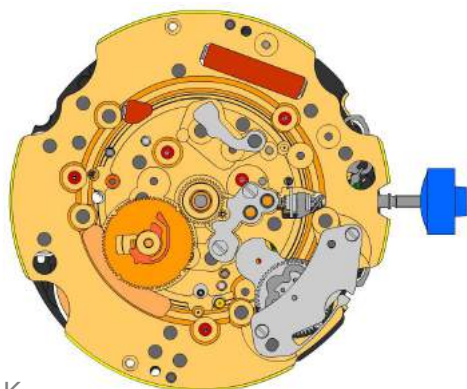

K

2130.143 61.		Wechselradbrücke Wechselradbrücke gehalten durch 2 Schrauben 4000.305.
4000.305 62.		Schraube
3004.227 63.		Zehnermitnehmerrad Die Teile 3004.227 und 3500.075 sind zusammen auszutauschen. Kurzer Zahn des Zehnermitnehmerrades in Richtung Werkszentrum positionieren.
3500.075 64.		Zehneraste Die Teile 3004.227 und 3500.075 sind zusammen auszutauschen.
2130.142 65.		Halteplatte für Zehneraste Halteplatte für Zehneraste gehalten durch 2 Schrauben 4000.306. Den Federarm spannen.
4010.306 66.		Schraube
3301.242 67.		Stundenrad (Aig.2)
3315.016 68.		Frikionsfeder
3004.224.CO 69.		Datumanzeiger-Mitnehmerrad
3500.049 70.		Datumraste

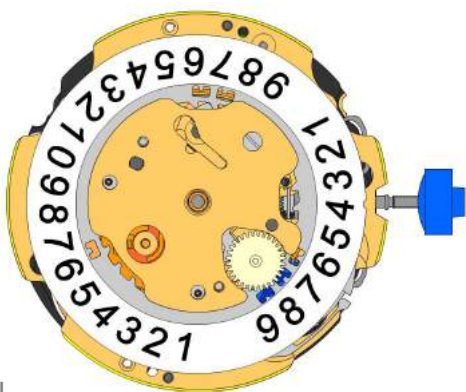





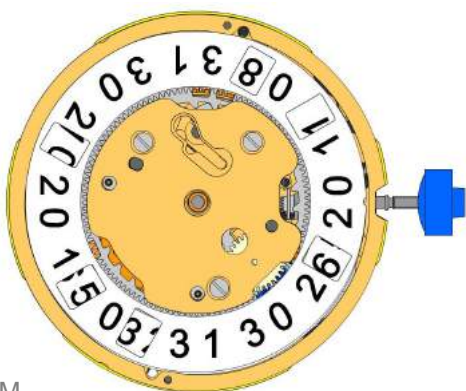



L

3504.214.AD.1.A 71.		Einer Anzeiger (Standard) Einbuchtung im Disc bei 3 Uhr.
3147.054 72.		Zehnerzwischenrad
2130.141 73.		Halteplatte für Datumanzeige Halteplatte für Datumanzeige gehalten durch 1 Schraube 4000.250.
3905.070 74.		Feder für Datumraste Feder für Datumsraste in die Öffnung einfügen.



M

3504.215.AD.1.A 75.		Zehner Anzeiger (Standard) Einbuchtung im Disc bei 3 Uhr.
2130.140.G 76.		Halteplatte für Datum-Mechanismus Halteplatte für Datum-Mechanismus gehalten durch 2 Schrauben 4000.250.
4000.250 77.		Schraube
3506.072.G 78.		Träger für Zifferblatt
8200 79.		Moebius 8200
9014 80.		Moebius 9014
124 81.		Jismaa 124
9020 82.		Moebius 9020

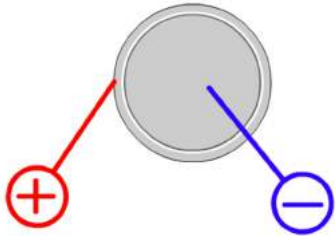

Batterie	395
Spannung	1.55 V

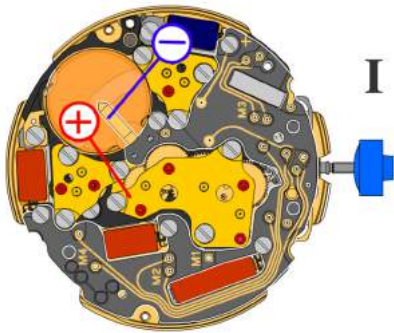

*Stellwelle in Position I, Kalender nicht im Eingriff,
60 s Messintervall für Gang und Verbrauch:*

Typischer Verbrauch	1.32 μA
Maximaler Verbrauch	1.65 μA
Gang	-10s/M. .. +20s/M.
Untere Funktionsspannungsgrenze	1.20 V

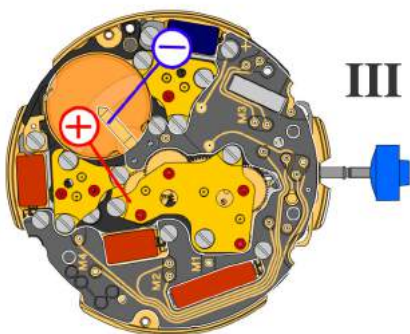

Stellwelle in Position III, 60 s Messintervall:

Typischer Verbrauch	0.10 μA
Maximaler Verbrauch	0.30 μA

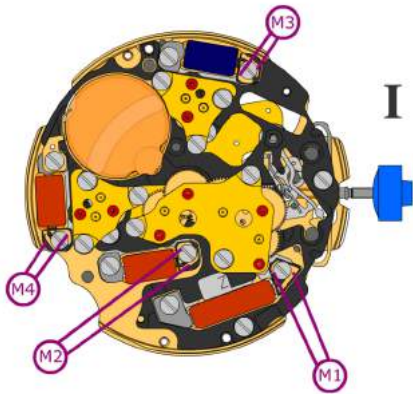

Spulenwiderstand M1 **1.90 k Ω .. 2.10 k Ω**

Spulenwiderstand M2 **1.68 k Ω .. 1.88 k Ω**

Spulenwiderstand M3 **1.68 k Ω .. 1.88 k Ω**

Spulenwiderstand M4 **1.68 k Ω .. 1.88 k Ω**

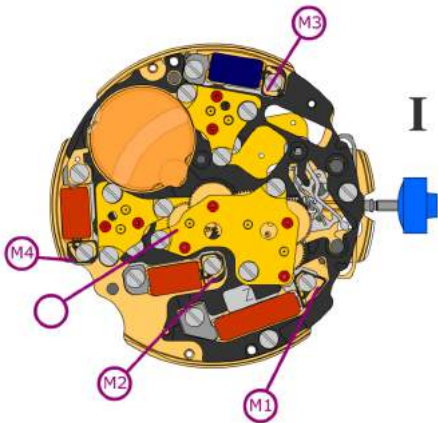

Spulenisolation M1/M2/M3/M4 **∞ k Ω**

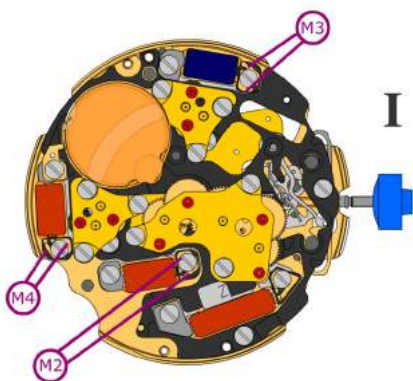

Pulsgenerator (4.9 ms, 8 Hz):

Untere Funktionsspannungsgrenze M2/M3/M4 **1.20 V**