

A

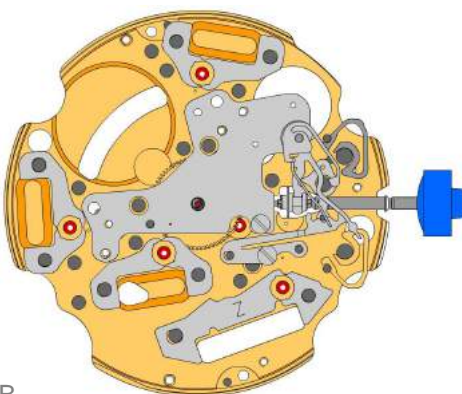

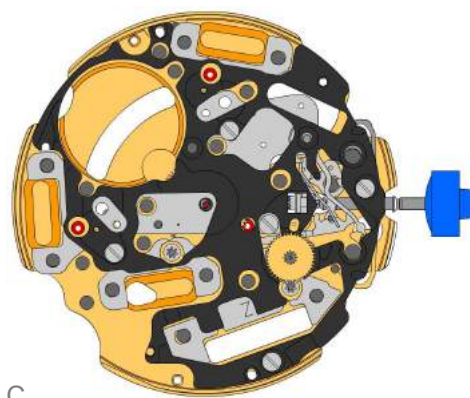



B

2000.574.G 1.		Platine
3305.282.CO 2.		Chaussée avec entraîneur (Aig.2)
3301.244 3.		Roue des heures (cpt 24h)
2030.032.CO 4.		Pont de centre Pont de centre tenue par 1 vis 4000.250.
4000.250 5.		Vis
3001.055.FI 6.		Pignon coulant
3000.177.CO 7.		Tige de mise à l'heure
3017.049 8.		Tirette
3905.049 9.		Sautoir de tirette (3 positions) Sautoir de tirette tenue par 1 vis 4000.250.
3015.081 10.		Bascule (3 positions) Die Teile 3015.081 et 3905.067 sind zusammen auszutauschen.
3905.067 11.		Ressort de bascule Mise en tension du ressort.
3406.030 12.		Sautoir de poussoir B Fixer le sautoir de poussoir gris entre les deux piliers plus loin.
3406.038 13.		Sautoir de poussoir A Fixer le sautoir de poussoir jaune entre les deux piliers plus proche.
3622.040 14.		Stator Marquage [Z] sur le stator.
3622.039 15.		Stator (cpt 6h, 9h, chrono)
3622.039 16.		Stator (cpt 6h, 9h, chrono)
3622.039 17.		Stator (cpt 6h, 9h, chrono)
4000.250 18.		Vis

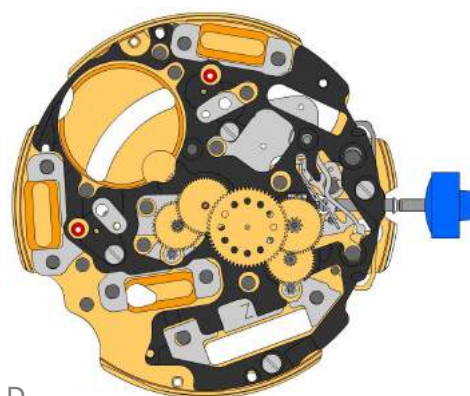



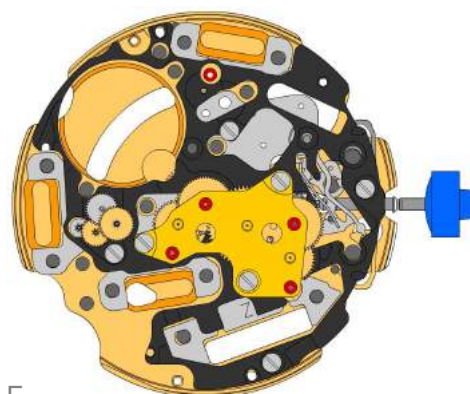

C

3603.079 19.		Potence plastique Potence plastique tenue par 4 vis 4000.250.
4000.250 20.		Vis
3715.094.RK 21.		Rotor
3715.094.RK 22.		Rotor
3147.046.CO 23.		Roue intermédiaire





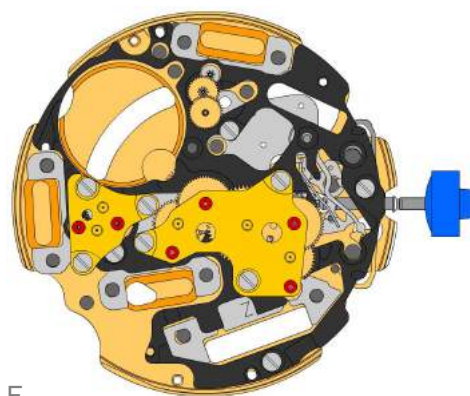

D

3136.142.CO 24.		Roue de seconde (longue)
3147.047.CO 25.		Roue intermédiaire (chrono)
3136.144.CO 26.		Roue de chronographe (Aig.2)
3122.056.CO 27.		Roue moyenne

E

2020.148.G 28.		Pont de rouage Pont de rouage tenue par 3 vis 4000.250.
4000.250 29.		Vis
3715.095.RK 30.		Rotor
3147.048.CO 31.		Roue intermédiaire (cpt)
3007.056.CO 32.		Roue de minuterie (cpt 24h)
3402.008.CO 33.		Roue compteuse de minutes



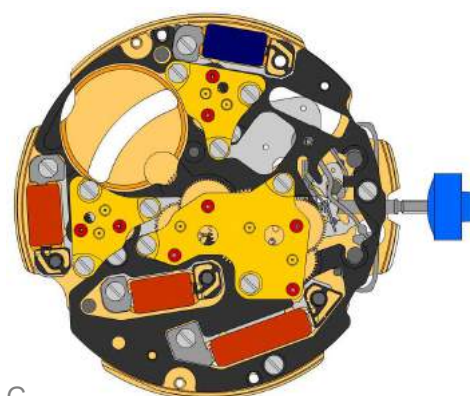

F

2020.149.G 34.		Pont de rouage compteur Pont de rouage compteur tenue par 3 vis 4000.250.
4000.250 35.		Vis
3715.095.RK 36.		Rotor
3147.053.CO 37.		Roue intermédiaire (cpt 1/10sec)
3402.016.CO 38.		Roue compteuse de 1/10 sec

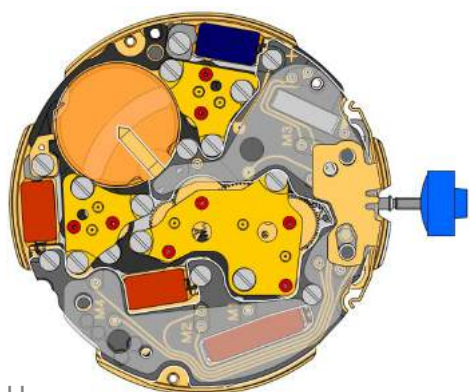

G

2020.149.G 39.		Pont de rouage compteur Pont de rouage compteur tenue par 3 vis 4000.250.
4000.250 40.		Vis
3621.053.RK 41.		Bobine Attention: Prendre la bobine uniquement par le noyau de bobine gris. Bobine tenue par 1 vis 4000.250.
3621.054.RK 42.		Bobine (cpt 9h, chrono) Attention: Prendre la bobine uniquement par le noyau de bobine gris. Bobine tenue par 1 vis 4000.250.
3621.054.RK 43.		Bobine (cpt 9h, chrono) Attention: Prendre la bobine uniquement par le noyau de bobine gris. Bobine tenue par 1 vis 4000.250.
3621.055.RK 44.		Bobine (cpt 6h) Attention: Prendre la bobine uniquement par le noyau de bobine gris. Bobine tenue par 1 vis 4000.250.
4000.250 45.		Vis
3601.118 46.		Bride contact Bride contact gehalten durch 1 Schraube 4000.250.
3603.034 47.		Isolateur pile

H

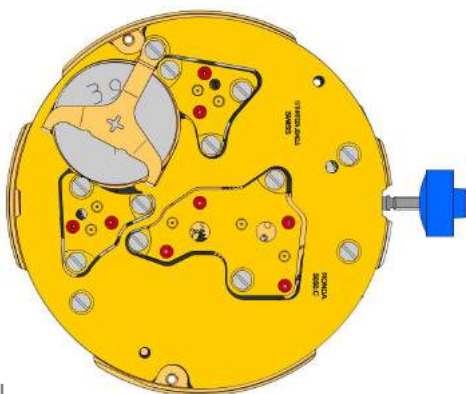
3612.144.5050 48.		Module électronique Module électronique tenue par 5 vis 4000.248. Les mesures électroniques peuvent être réaliser maintenant.
4000.248 49.		Vis
3603.069 50.		Isolateur de circuit
3601.107.G 51.		Ressort contact pousoirs



2130.137.G.M01.5050C 52.  **Couvre-module électronique**
Couvre-module électronique tenue par 3 vis 4000.250.

3600.010.HGF 53.  **Pile 395**





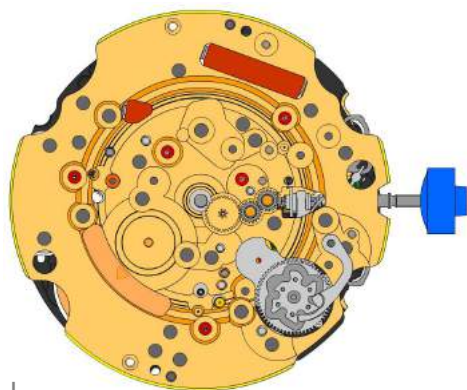



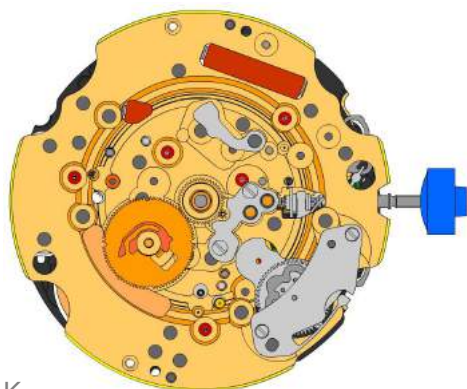

3601.109.G 54.  **Bride +**
Bride tenue par 1 vis 4000.250.

4000.250 55.  **Vis**

J

2000.574.G 56.		Platine
3004.164 57.		Renvoi
3004.164 58.		Renvoi
3007.054.CO 59.		Roue de minuterie

K

2130.143 60.		Pont du rouage de minuterie Pont du rouage de minuterie tenue par 2 vis 4000.305.
4000.305 61.		Vis
3004.227 62.		Roue entraîneuse des dizaines Les pièces 3004.227 et 3500.075 doivent être échangées ensemble. Positionnement de la dent courte de la roue entraîneuse des dizaines en direction le centre du mouvement.
3500.075 63.		Sautoir des dizaines Les pièces 3004.227 et 3500.075 doivent être échangées ensemble.
2130.142 64.		Plaque de maintien du sautoir des dizaines Plaque maintien sautoir des dizaines tenue par 2 vis 4000.306. Mise en tension du ressort.
4010.306 65.		Vis
3301.242 66.		Roue des heures (Aig.2)
3315.016 67.		Clinquant
3004.224.CO 68.		Roue entraîneuse de quantième
3500.049 69.		Sautoir de quantième

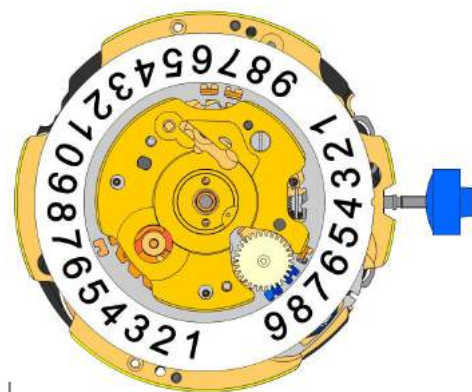

L

3504.214.AD.1.A 70.		Indicateur des unités (standard) Marquage de l'indicateur à 3 heures.
3147.054 71.		Roue intermédiaire dizaines
2130.163 72.		Plaque de maintien de l'indicateur de quantième Plaque maintien indicateur de quantième tenue par 1 vis 4000.282.
3905.070 73.		Ressort sautoir de quantième Insertion du ressort sautoir de quantième dans l'ouverture.







M

3504.215.AD.1.A 74.		Indicateur des dizaines (standard) Marquage de l'indicateur à 3 heures.
3500.055 75.		Sautoir des jours
3004.175 76.		Doigt des jours Placer le doigt des jours selon image.
2130.162.G 77.		Plaque de maintien du mécanisme de quantième Plaque maintien mécanisme de quantième tenue par 2 vis 4000.312 et 1 vis 4000.300.



N

3508.155.AF.E.A 78.		Indicateur du jour (standard)
2130.164.G 79.		Plaque de maintien de l'indicateur du jour Plaque maintien indicateur du jour tenue par 2 vis 4000.311.
4000.311 80.		Vis
3506.072.G 81.		Support de cadran
4000.282 82.		Vis
4000.300 83.		Vis
4000.312 84.		Vis

8200 85.		Moebius 8200
9014 86.		Moebius 9014
124 87.		Jismaa 124
9020 88.		Moebius 9020

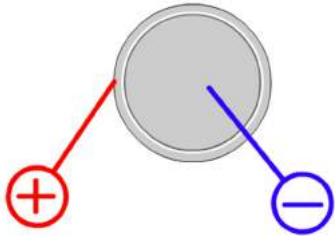

Pile	395
Tension	1.55 V

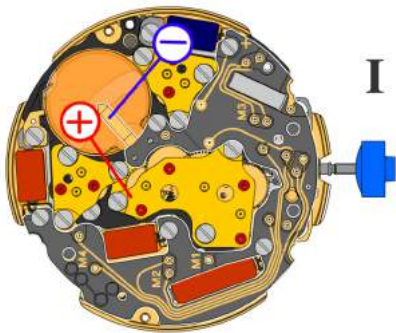

Tige de mise à l'heure en position I, calendrier hors engrenage, intervalle de mesure 60 s pour la marche et la consommation:

Consommation typique	1.32 μA
Consommation maximale	1.65 μA
Marche	-10s/M. .. +20s/M.
Limite inférieure de la tension de fonctionnement	1.20 V

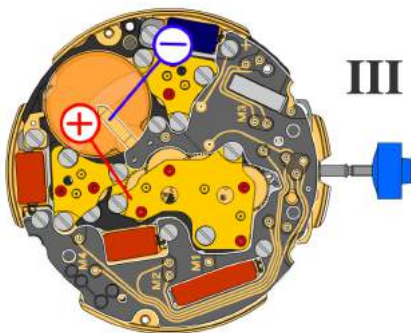

Tige de mise à l'heure en position III, intervalle de mesure 60 s:

Typical consumption	0.10 μA
Maximal consumption	0.30 μA

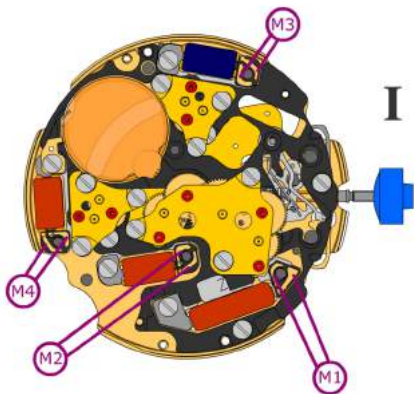

Résistance de la bobine M1 **1.90 kΩ .. 2.10 kΩ**

Résistance de la bobine M2 **1.68 kΩ .. 1.88 kΩ**

Résistance de la bobine M3 **1.68 kΩ .. 1.88 kΩ**

Résistance de la bobine M4 **1.68 kΩ .. 1.88 kΩ**

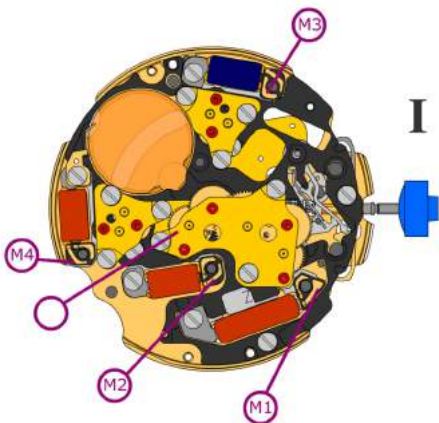

Isolation de la bobine
M1/M2/M3/M4 **∞ kΩ**

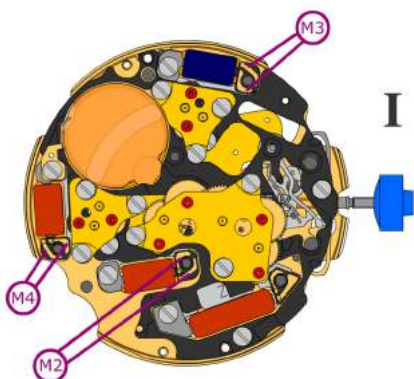

Générateur d'impulsion
(4.9 ms, 8 Hz):



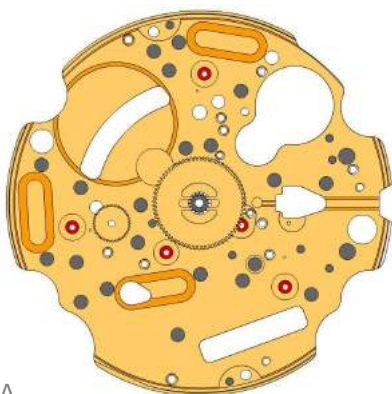



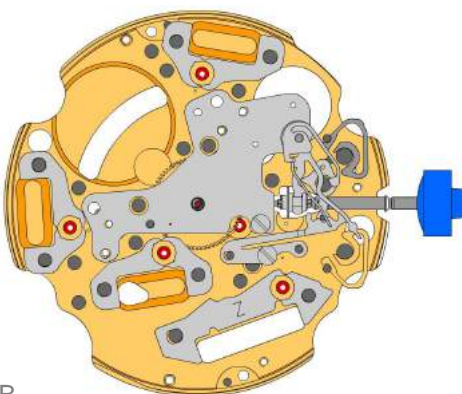











Limite inférieure de la tension de
fonctionnement M2/M3/M4 **1.20 V**









A

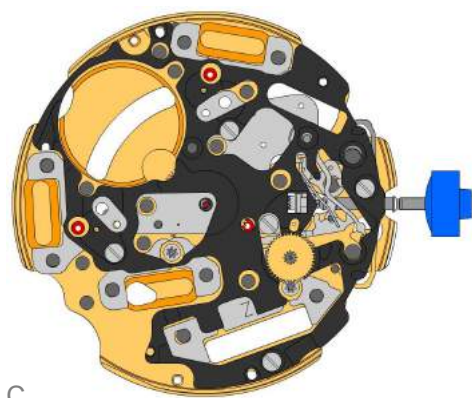





B

2000.574.G 1.		Main plate
3305.282.CO 2.		Cannon pinion with driver (Aig.2)
3301.244 3.		Hour wheel (counter 24h)
2030.032.CO 4.		Centre bridge Centre bridge held by 1 screw 4000.250.
4000.250 5.		Screw
3001.055.FI 6.		Sliding pinion
3000.177.CO 7.		Setting stem
3017.049 8.		Setting lever
3905.049 9.		Setting lever jumper (3 positions) Setting lever jumper held by 1 screw 4000.250.
3015.081 10.		Yoke (3 positions) Parts 3015.081 and 3905.067 must be exchanged together.
3905.067 11.		Yoke spring Tensioning the spring arm.
3406.030 12.		Pusher jumper B Put the grey jumper between the two posts on the further side.
3406.038 13.		Pusher jumper A Put the yellow jumper between the two posts on the closer side.
3622.040 14.		Stator Mark [Z] on stator.
3622.039 15.		Stator (counter 6h, 9h, chrono)
3622.039 16.		Stator (counter 6h, 9h, chrono)
3622.039 17.		Stator (counter 6h, 9h, chrono)
4000.250 18.		Screw

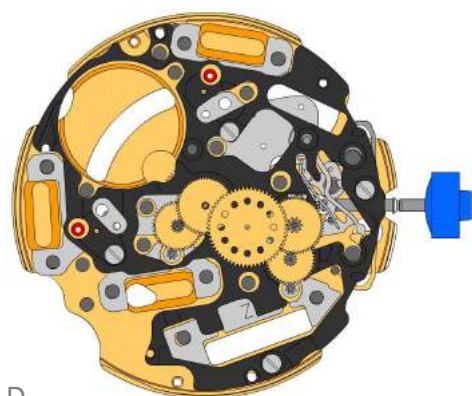



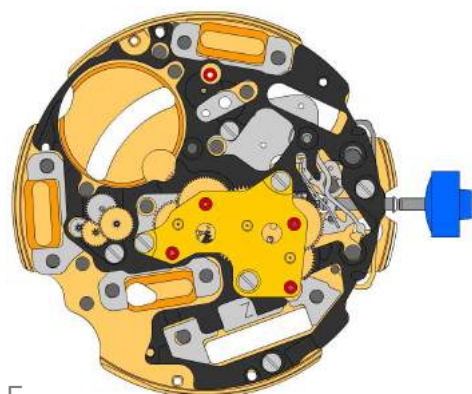

C

3603.079 19.		Plastic bracket Plastic bracket held by 4 screws 4000.250.
4000.250 20.		Screw
3715.094.RK 21.		Rotor
3715.094.RK 22.		Rotor
3147.046.CO 23.		Intermediate wheel

D





3136.142.CO 24.		Second wheel (long)
3147.047.CO 25.		Intermediate wheel (chrono)
3136.144.CO 26.		Chronograph wheel (Aig.2)
3122.056.CO 27.		Third wheel

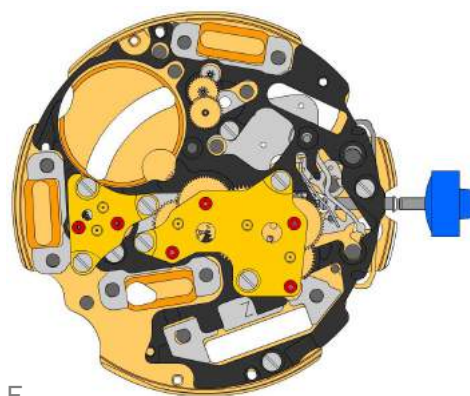

E

2020.148.G 28.		Train wheel bridge Train wheel bridge held by 3 screws 4000.250.
4000.250 29.		Screw
3715.095.RK 30.		Rotor
3147.048.CO 31.		Intermediate wheel (counter)
3007.056.CO 32.		Minute wheel (counter 24h)
3402.008.CO 33.		Minute counting wheel

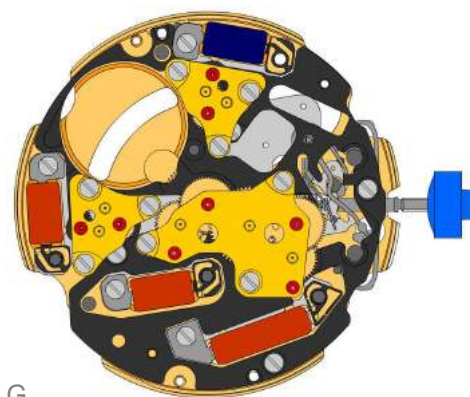

F

2020.149.G 34.		Counter train wheel bridge Counter train wheel bridge held by 3 screws 4000.250.
4000.250 35.		Screw
3715.095.RK 36.		Rotor
3147.053.CO 37.		Intermediate wheel (counter 1/10sec)
3402.016.CO 38.		Counting wheel 1/10 sec





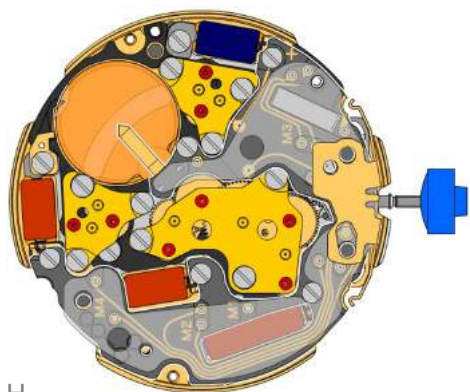

G

2020.149.G 39.		Counter train wheel bridge Counter train wheel bridge held by 3 screws 4000.250.
4000.250 40.		Screw
3621.053.RK 41.		Coil Attention: Please hold the coil only on the grey coil core. Coil held by 1 screw 4000.250.
3621.054.RK 42.		Coil (counter 9h, chrono) Attention: Please hold the coil only on the grey coil core. Coil held by 1 screw 4000.250.
3621.054.RK 43.		Coil (counter 9h, chrono) Attention: Please hold the coil only on the grey coil core. Coil held by 1 screw 4000.250.
3621.055.RK 44.		Coil (counter 6h) Attention: Please hold the coil only on the grey coil core. Coil held by 1 screw 4000.250.
4000.250 45.		Screw
3601.118 46.		Contact strip Contact strip tenue par 1 vis 4000.
3603.034 47.		Battery insulator Contact strip held by 1 screw 4000.250.



H

3612.144.5050 48.		Electronic module Electronic module held by 5 screws 4000.248. Electronic measurements may be realised now.
4000.248 49.		Screw
3603.069 50.		Circuit insulator
3601.107.G 51.		Pusher contact spring

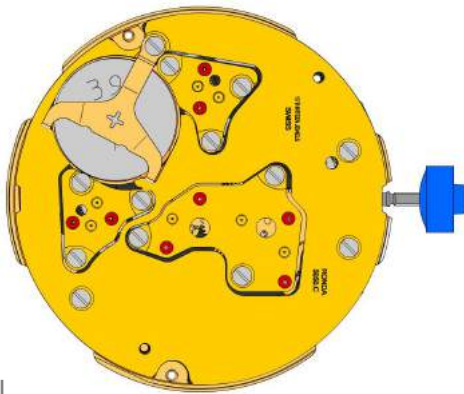









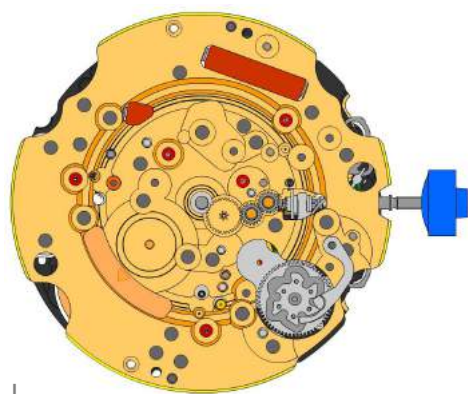
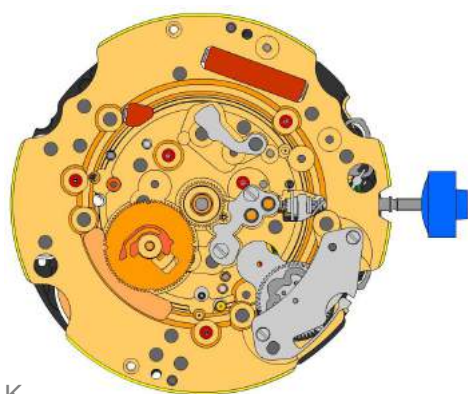





2130.137.G.M01.5050C
52.  **Electronic module cover**
Electronic module cover held by 3 screws 4000.250.

3600.010.HGF
53.  **Battery 395**

3601.109.G
54.  **Bridge +**
Bridge held by 1 screw 4000.250.



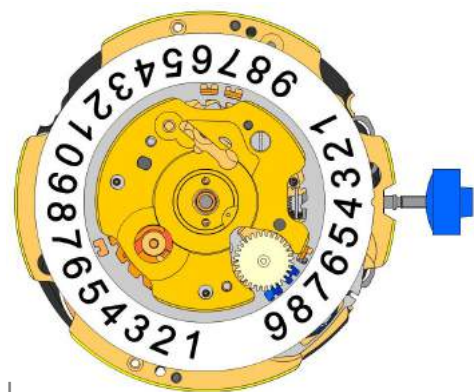

4000.250
55.  **Screw**

J

K

2000.574.G 56.		Main plate
3004.164 57.		Setting wheel
3004.164 58.		Setting wheel
3007.054.CO 59.		Minute wheel
2130.143 60.		Minute train bridge Minute train bridge held by 2 screws 4000.305.
4000.305 61.		Screw
3004.227 62.		Tens indicator driving wheel Parts 3004.227 and 3500.75 must be exchanged together. The short tooth of the tens indicator driving wheel must point to the center of the movement.
3500.075 63.		Tens jumper Parts 3004.227 and 3500.75 must be exchanged together.
2130.142 64.		Tens jumper maintaining plate Tensioning the spring arm. Tens jumper maintaining plate held by 2 screws 4000.306.
4010.306 65.		Screw
3301.242 66.		Hour wheel (Aig.2)
3315.016 67.		Friction spring
3004.224.CO 68.		Date indicator driving wheel
3500.049 69.		Date jumper







L

3504.214.AD.1.A 70.		Units indicator (standard) Nick of the indicator at 3 o'clock.
3147.054 71.		Tens intermediate wheel
2130.163 72.		Date indicator maintaining plate Date indicator maintaining plate held by 1 screw 4000.282.
3905.070 73.		Date jumper spring Insert the date jumper spring in the provided opening.













M

3504.215.AD.1.A 74.		Tens indicator (standard) Nick of the indicator at 3 o'clock.
3500.055 75.		Day jumper
3004.175 76.		Day finger Place Day finger as shown on graphic.
2130.162.G 77.		Date mechanism maintaining plate Date mechanism maintaining plate held by 2 screws 4000.312 and 1 screw 4000.300.



N

3508.155.AF.E.A 78.		Day indicator (standard)
2130.164.G 79.		Day indicator maintaining plate Day indicator maintaining plate held by 2 screws 4000.311.
4000.311 80.		Screw
3506.072.G 81.		Dial support
4000.282 82.		Screw
4000.300 83.		Screw
4000.312 84.		Screw

8200 85.		Moebius 8200
9014 86.		Moebius 9014
124 87.		Jismaa 124
9020 88.		Moebius 9020

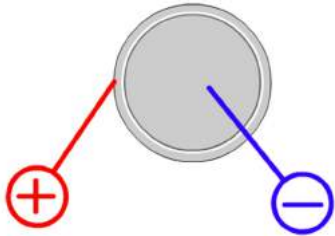

Battery	395
Voltage	1.55 V

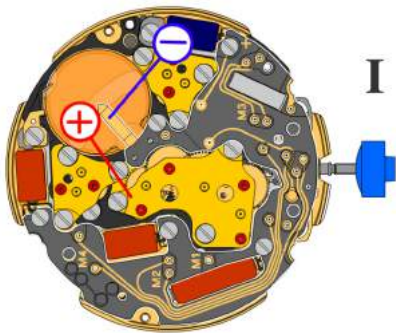

*Setting stem in position I, calendar not in gear,
60 s measuring interval for rate and consumption:*

Typical consumption	1.32 μA
Maximal consumption	1.65 μA
Rate	-10s/M. .. +20s/M.
Lower working voltage limit	1.20 V

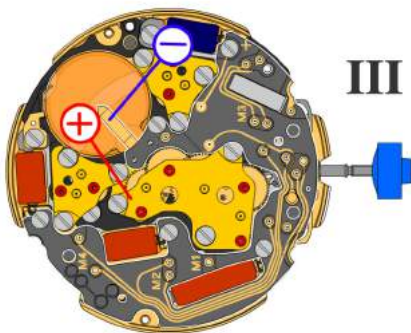

Setting stem in position III, 60 s measuring interval:

Typical consumption	0.10 μA
Maximal consumption	0.30 μA

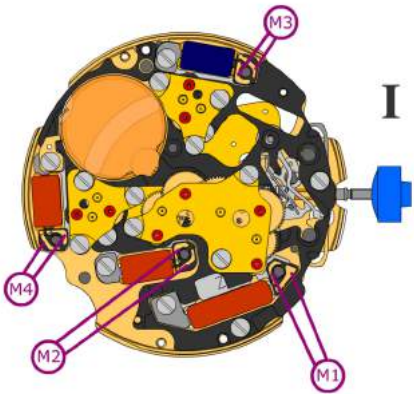

Coil resistance M1 **1.90 k Ω .. 2.10 k Ω**

Coil resistance M2 **1.68 k Ω .. 1.88 k Ω**

Coil resistance M3 **1.68 k Ω .. 1.88 k Ω**

Coil resistance M4 **1.68 k Ω .. 1.88 k Ω**

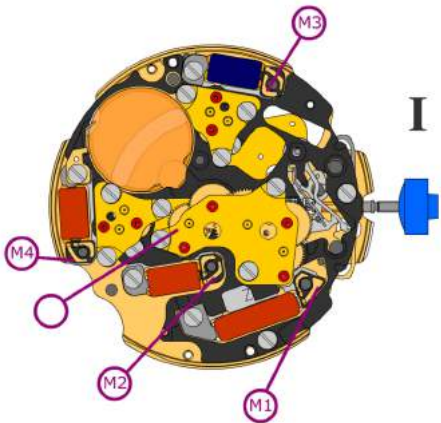

Coil isolation M1/M2/M3/M4 **∞ k Ω**

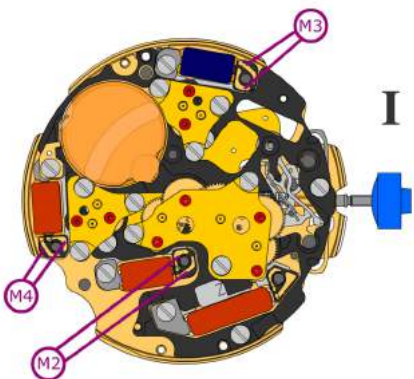

Signal generator (4.9 ms, 8 Hz):

Lower working voltage limit M2/M3/M4 **1.20 V**

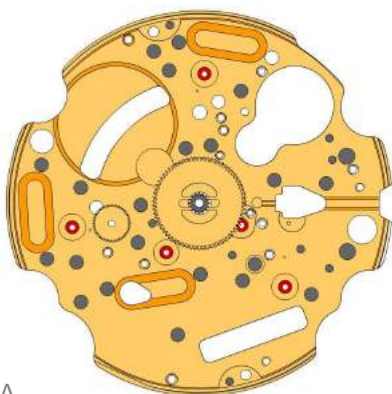

A

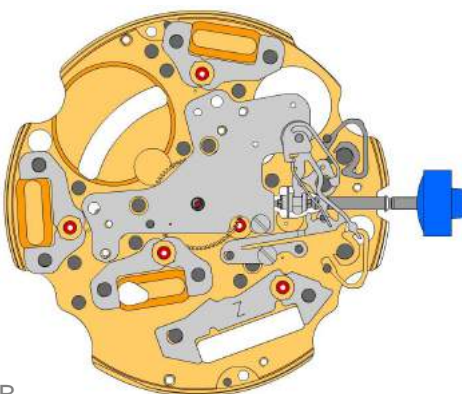



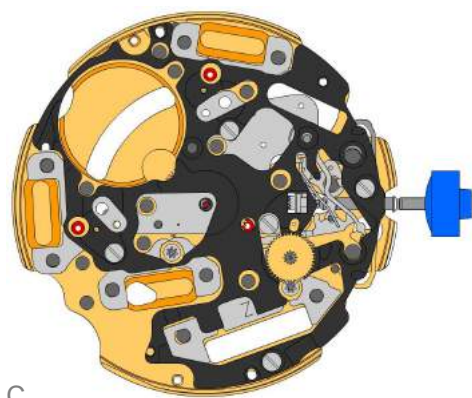

B

2000.574.G 1.		Werkplatte
3305.282.CO 2.		Minutenrohr mit Mitnehmer (Aig.2)
3301.244 3.		Stundenrad (Zähler 24h)
2030.032.CO 4.		Zentrumbrücke Zentrumbrücke gehalten durch 1 Schraube 4000.250.
4000.250 5.		Schraube
3001.055.FI 6.		Kupplungstrieb
3000.177.CO 7.		Stellwelle
3017.049 8.		Winkelhebel
3905.049 9.		Winkelhebelraste (3 Positionen) Winkelhebelraste gehalten durch 1 Schraube 4000.250.festschrauben.
3015.081 10.		Wippe (3 Positionen) Die Teile 3015.081 und 3905.067 sind zusammen auszutauschen.
3905.067 11.		Wippenfeder Den Federarm spannen.
3406.030 12.		Drückerraste B Graue Drückerraste zwischen den beiden Säulen auf der entfernteren Seite platzieren.
3406.038 13.		Drückerraste A Gelbe Drückerraste zwischen den beiden Säulen auf der näheren Seite platzieren.
3622.040 14.		Stator Markierung [Z] auf Stator.
3622.039 15.		Stator (Zähler 6h, 9h, Chrono)
3622.039 16.		Stator (Zähler 6h, 9h, Chrono)
3622.039 17.		Stator (Zähler 6h, 9h, Chrono)
4000.250 18.		Schraube



C

3603.079 19.		Kunststoffhalterung Kunststoffhalterung gehalten durch 4 Schrauben 4000.250.
4000.250 20.		Schraube
3715.094.RK 21.		Rotor
3715.094.RK 22.		Rotor
3147.046.CO 23.		Zwischenrad

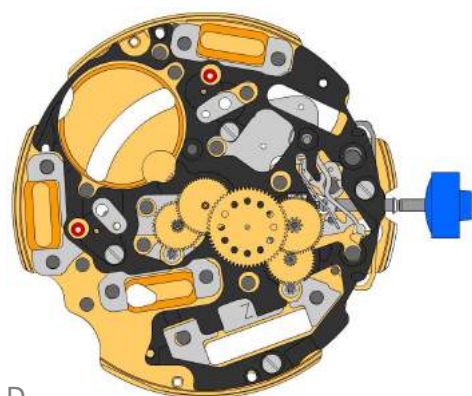

D

3136.142.CO 24.		Sekundenrad (lang)
3147.047.CO 25.		Zwischenrad (Chrono)
3136.144.CO 26.		Chrono-Zentrumrad (Aig.2)
3122.056.CO 27.		Kleinbodenrad

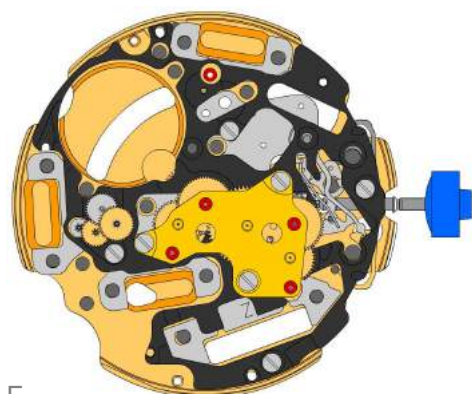

E

2020.148.G 28.		Räderwerkbrücke Räderwerkbrücke gehalten durch 3 Schrauben 4000.250.
4000.250 29.		Schraube
3715.095.RK 30.		Rotor
3147.048.CO 31.		Zwischenrad (Zähler)
3007.056.CO 32.		Wechselrad (Zähler 24h)
3402.008.CO 33.		Minutenzählrad

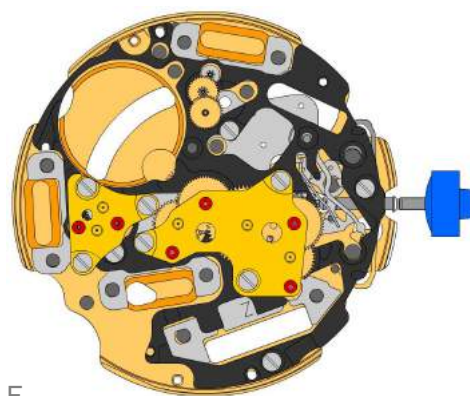

F

2020.149.G 34.		Zähler-Räderwerkbrücke Zähler-Räderwerkbrücke gehalten durch 3 Schrauben 4000.250.
4000.250 35.		Schraube
3715.095.RK 36.		Rotor
3147.053.CO 37.		Zwischenrad (Zähler 1/10sek)
3402.016.CO 38.		Zählrad 1/10 sek

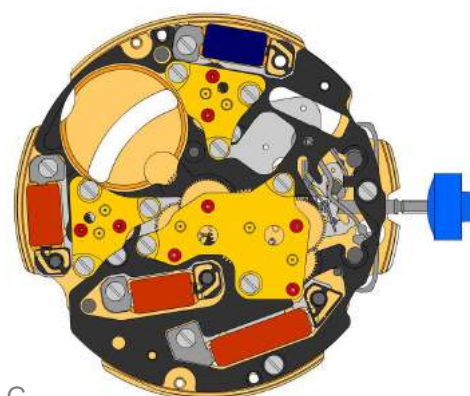

G



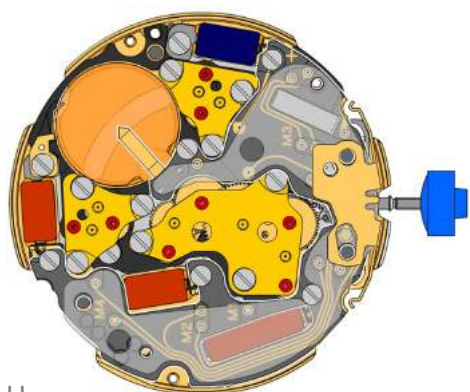

2020.149.G 39.		Zähler-Räderwerkbrücke Zähler-Räderwerkbrücke gehalten durch 3 Schrauben 4000.250.
4000.250 40.		Schraube
3621.053.RK 41.		Spule Achtung: Spule nur am grauen Spulenkern halten. Spule gehalten durch 1 Schraube 4000.250.
3621.054.RK 42.		Spule (Zähler 9h, Chrono) Achtung: Spule nur am grauen Spulenkern halten. Spule gehalten durch 1 Schraube 4000.250.
3621.054.RK 43.		Spule (Zähler 9h, Chrono) Achtung: Spule nur am grauen Spulenkern halten. Spule gehalten durch 1 Schraube 4000.250.
3621.055.RK 44.		Spule (Zähler 6h) Achtung: Spule nur am grauen Spulenkern halten. Spule gehalten durch 1 Schraube 4000.250.
4000.250 45.		Schraube
3601.118 46.		Kontaktbügel Kontaktbügel gehalten durch 1 Schraube 4000.250.
3603.034 47.		Isolation für Batterie

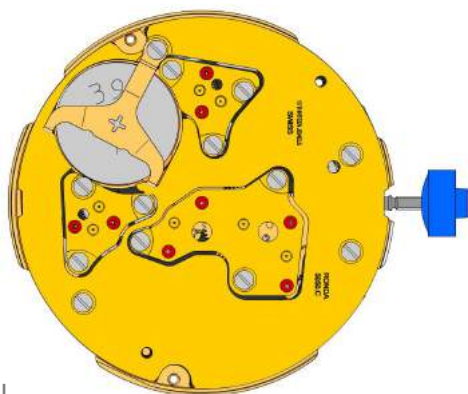

H

3612.144.5050 48.		Elektronikmodul Elektronikmodul gehalten durch 5 Schrauben 4000.248. Elektronische Messungen können nun vorgenommen werden.
4000.248 49.		Schraube
3603.069 50.		Isolation für Schaltung
3601.107.G 51.		Drückerkontaktfeder



2130.137.G.M01.5050C 52.		Deckplatte für Elektronikmodul Deckplatte für Elektronikmodul gehalten durch 3 Schrauben 4000.250.
3600.010.HGF 53.		Batterie 395
3601.109.G 54.		Bügel + Bügel gehalten durch 1 Schraube 4000.250.
4000.250 55.		Schraube

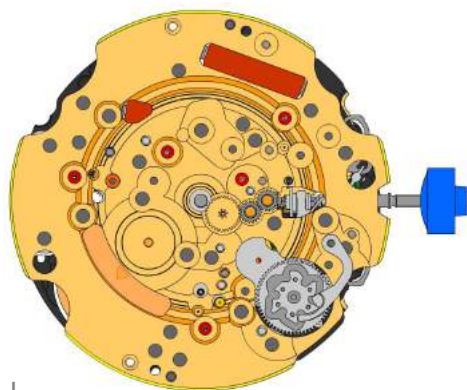

J

2000.574.G 56.		Werkplatte
3004.164 57.		Zeigerstellrad
3004.164 58.		Zeigerstellrad
3007.054.CO 59.		Wechselrad Ölen mit Moebius 9020.

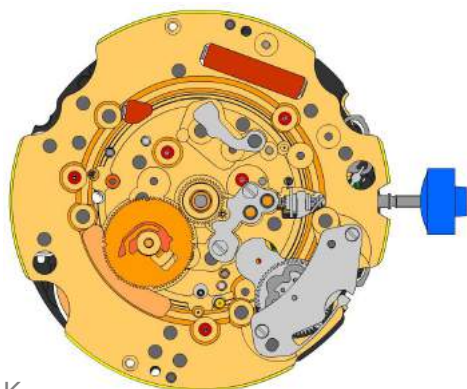

K

2130.143 60.		Wechselradbrücke Wechselradbrücke gehalten durch 2 Schrauben 4000.305.
4000.305 61.		Schraube
3004.227 62.		Zehnermitnehmerrad Die Teile 3004.227 und 3500.075 sind zusammen auszutauschen. Kurzer Zahn des Zehnermitnehmerrades in Richtung Werkszentrum positionieren.
3500.075 63.		Zehneraste Die Teile 3004.227 und 3500.075 sind zusammen auszutauschen.
2130.142 64.		Halteplatte für Zehneraste Halteplatte für Zehneraste gehalten durch 2 Schrauben 4000.306. Federarm hinter die Zehneraste spannen.
4010.306 65.		Schraube
3301.242 66.		Stundenrad (Aig.2)
3315.016 67.		Friktionsfeder
3004.224.CO 68.		Datumanzeiger-Mitnehmerrad
3500.049 69.		Datumraste

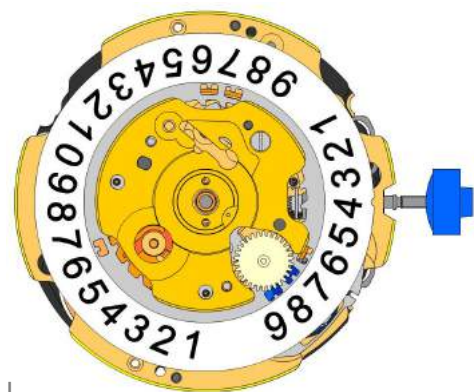

L

3504.214.AD.1.A 70.		Einer Anzeiger (Standard) Einbuchtung im Disc bei 3 Uhr.
3147.054 71.		Zehnerzwischenrad
2130.163 72.		Halteplatte für Datumanzeige Halteplatte für Datumanzeige gehalten durch 1 Schraube 4000.282.
3905.070 73.		Feder für Datumraste Feder für Datumsraste in die Öffnung einfügen.







M

3504.215.AD.1.A 74.		Zehner Anzeiger (Standard) Einbuchtung im Disc bei 3 Uhr.
3500.055 75.		Tagesraste
3004.175 76.		Tagesfinger Tagesfinger wie abgebildet ausrichten.
2130.162.G 77.		Halteplatte für Datum-Mechanismus Halteplatte für Datum-Mechanismus gehalten durch 2 Schrauben 4000.312 und 1 Schraube 4000.300.



N

3508.155.AF.E.A 78.		Tagesanzeiger (Standard)
2130.164.G 79.		Halteplatte für Tagesanzeige Halteplatte für Tagesanzeige gehalten durch 2 Schrauben 4000.311.
4000.311 80.		Schraube
3506.072.G 81.		Träger für Zifferblatt
4000.282 82.		Schraube
4000.300 83.		Schraube
4000.312 84.		Schraube

8200 85.		Moebius 8200
9014 86.		Moebius 9014
124 87.		Jismaa 124
9020 88.		Moebius 9020

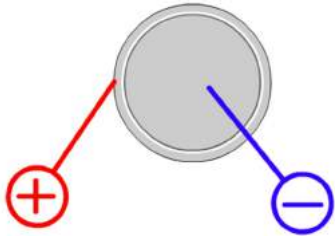

Batterie	395
Spannung	1.55 V

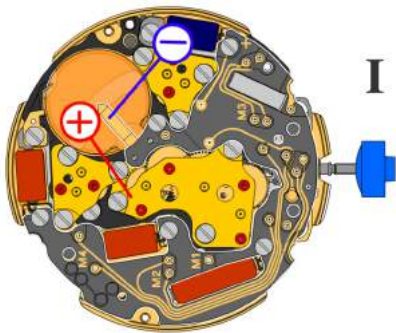

*Stellwelle in Position I, Kalender nicht im Eingriff,
60 s Messintervall für Gang und Verbrauch:*

Typischer Verbrauch	1.32 μA
Maximaler Verbrauch	1.65 μA
Gang	-10s/M. .. +20s/M.
Untere Funktionsspannungsgrenze	1.20 V

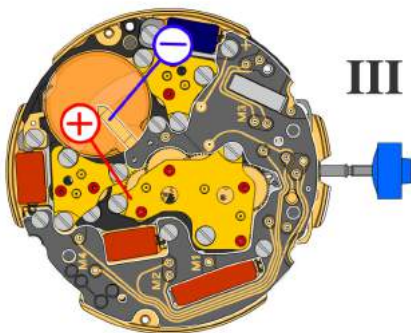

Stellwelle in Position III, 60 s Messintervall:

Typischer Verbrauch	0.10 μA
Maximaler Verbrauch	0.30 μA

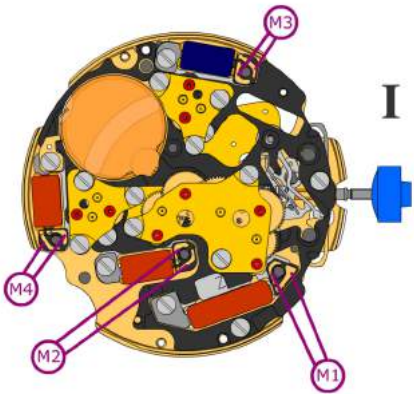

Spulenwiderstand M1 **1.90 k Ω .. 2.10 k Ω**

Spulenwiderstand M2 **1.68 k Ω .. 1.88 k Ω**

Spulenwiderstand M3 **1.68 k Ω .. 1.88 k Ω**

Spulenwiderstand M4 **1.68 k Ω .. 1.88 k Ω**

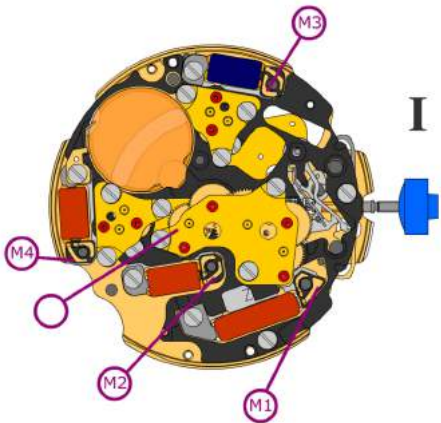

Spulenisolation M1/M2/M3/M4 **∞ k Ω**

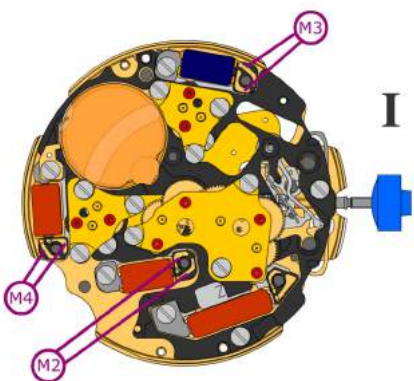

Pulsgenerator (4.9 ms, 8 Hz):

Untere Funktionsspannungsgrenze M2/M3/M4 **1.20 V**