

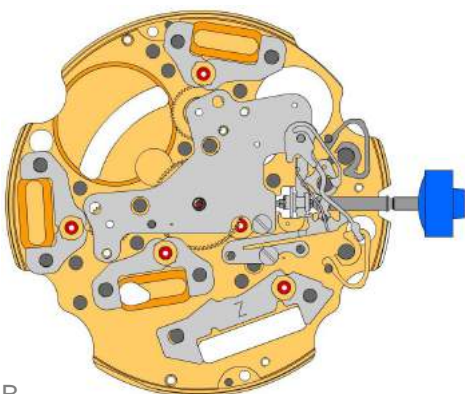

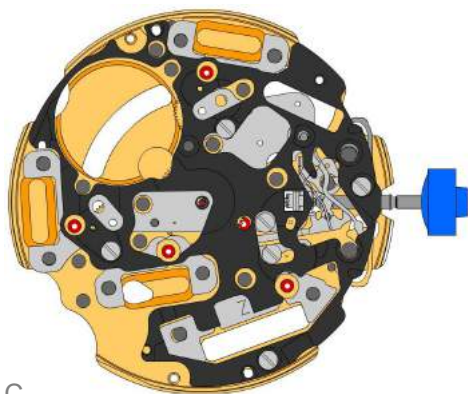

A

B



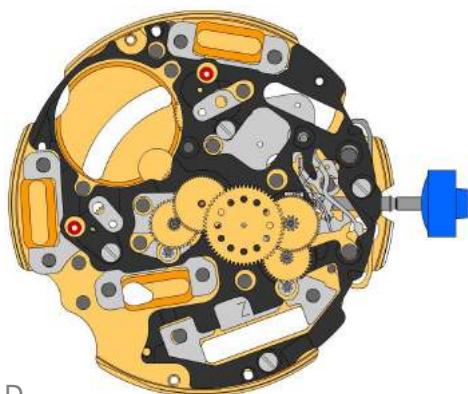

2000.574.G 1.		Platine
3305.282.CO 2.		Chaussée avec entraîneur (Aig.2)
3301.243 3.		Roue des heures (cpt 12h) (Alarme)
3301.244 4.		Roue des heures (cpt 24h) (Chrono)

2030.017.CO 5.		Pont de centre Pont de centre tenue par 1 vis 4000.250.
4000.250 6.		Vis
3001.055.FI 7.		Pignon coulant
3000.177.CO 8.		Tige de mise à l'heure
3017.049 9.		Tirette
3905.049 10.		Sautoir de tirette (3 positions) Sautoir de tirette tenue par 1 vis 4000.250.
4000.250 11.		Vis
3015.081 12.		Bascule (3 positions)
3905.067 13.		Ressort de bascule Mise en tension du ressort.
3406.030 14.		Sautoir de poussoir B Fixer le sautoir de poussoir gris entre les deux piliers plus loin.
3406.038 15.		Sautoir de poussoir A Fixer le sautoir de poussoir jaune entre les deux piliers plus proche.
3622.040 16.		Stator Marquage [Z] sur le stator.
3622.039 17.		Stator (cpt 6h, 9h, chrono)
3622.039 18.		Stator (cpt 6h, 9h, chrono)
3622.039 19.		Stator (cpt 6h, 9h, chrono)





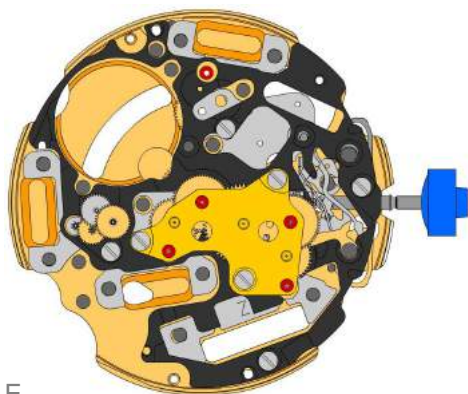

C

3603.079 20.		Potence plastique Potence plastique tenue par 4 vis 4000.250.
4000.250 21.		Vis
3715.094.RK 22.		Rotor
3715.094.RK 23.		Rotor

D

3147.046.CO 24.		Roue intermédiaire
3136.142.CO 25.		Roue de seconde (longue)
3147.047.CO 26.		Roue intermédiaire (chrono)
3136.144.CO 27.		Roue de chronographe (Aig.2)
3122.056.CO 28.		Roue moyenne

E

2020.148.G 29.		Pont de rouage Pont de rouage tenue par 3 vis 4000.250.
4000.250 30.		Vis
3715.095.RK 31.		Rotor
3147.048.CO 32.		Roue intermédiaire (cpt)
3007.056.CO 33.		Roue de minuterie (cpt 24h)
3402.008.CO 34.		Roue compteuse de minutes

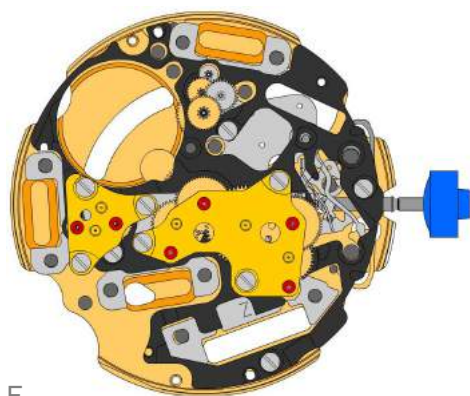
F

2020.149.G
35.  Pont de rouage compteur

4000.250
36.  Vis

3715.095.RK
37.  Rotor

3147.048.CO
38.  Roue intermédiaire (cpt)

3007.055.CO
39.  Roue de minuterie (cpt 12h)

3402.007.CO
40.  Roue compteuse de minutes

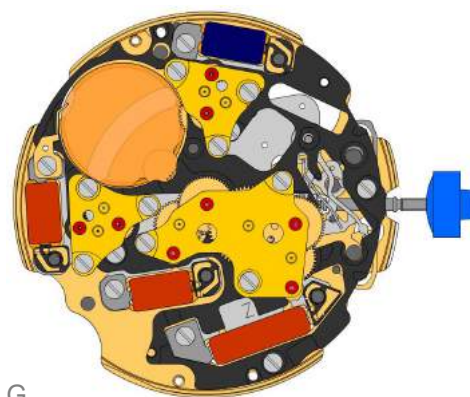

G

2020.149.G
41.  Pont de rouage compteur

4000.250
42.  Vis

4000.250
43.  Vis

3621.053.RK
44.  Bobine
Attention: Prendre la bobine uniquement par le noyau de bobine gris.
Bobine tenue par 1 vis 4000.250.









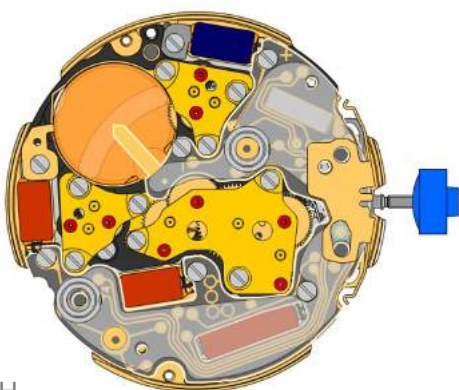
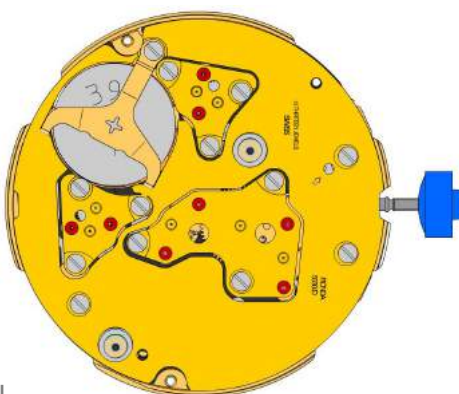



3621.054.RK
45.  Bobine (cpt 9h, chrono)
Attention: Prendre la bobine uniquement par le noyau de bobine gris.
Bobine tenue par 1 vis 4000.250.

3621.054.RK
46.  Bobine (cpt 9h, chrono)
Attention: Prendre la bobine uniquement par le noyau de bobine gris.
Bobine tenue par 1 vis 4000.250.

3621.055.RK
47.  Bobine (cpt 6h)
Attention: Prendre la bobine uniquement par le noyau de bobine gris.
Bobine tenue par 1 vis 4000.250.

4000.250
48.  Vis

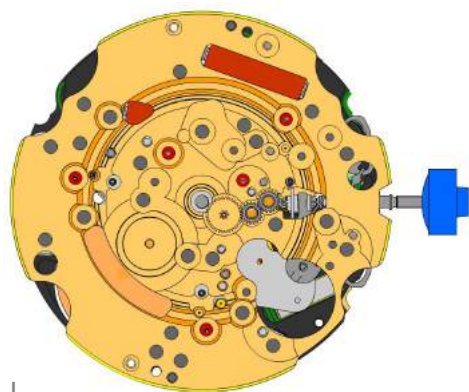

H

I

3601.118 49.		Bride contact Bride contact tenue par 1 vis 4000.250.
3603.034 50.		Isolateur pile
3612.176.5130 51.		Module électronique Module électronique tenue par 5 vis 4000.248. Les mesures électroniques peuvent être réaliser maintenant.
4000.248 52.		Vis
3603.069 53.		Isolateur de circuit
3603.070 54.		Isolateur de contact
3603.070 55.		Isolateur de contact
3601.107.G 56.		Ressort contact poussoirs
2130.159.G.M01.5130D 57.		Couvre-module électronique Couvre-module électronique tenue par 3 vis 4000.250.
3600.010.HGF 58.		Pile 395
3601.109.G 59.		Bride + Bride tenue par 1 vis 4000.250.
4000.250 60.		Vis



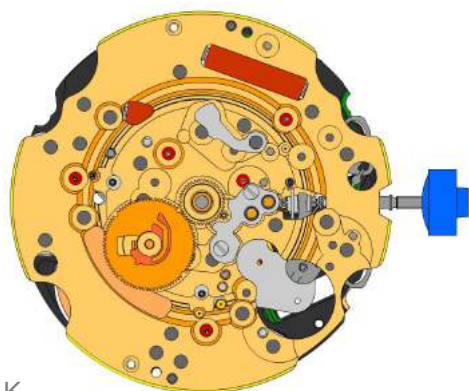

J

2000.574.G 61.		Platine
3004.164 62.		Renvoi
3004.164 63.		Renvoi
3007.054.CO 64.		Roue de minuterie



K

2130.143 65.		Pont du rouage de minuterie Pont du rouage de minuterie tenue par 2 vis 4000.305.
4000.305 66.		Vis
3301.242 67.		Roue des heures (Aig.2)
3315.016 68.		Clinquant
3004.224.CO 69.		Roue entraîneuse de quantième
3500.049 70.		Sautoir de quantième

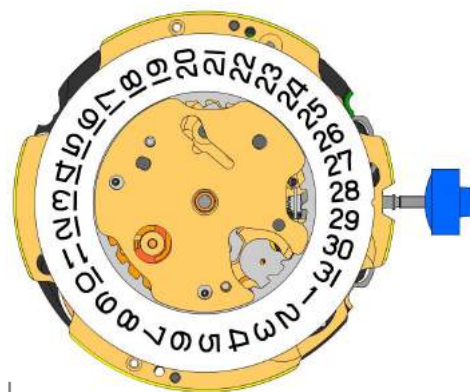

L

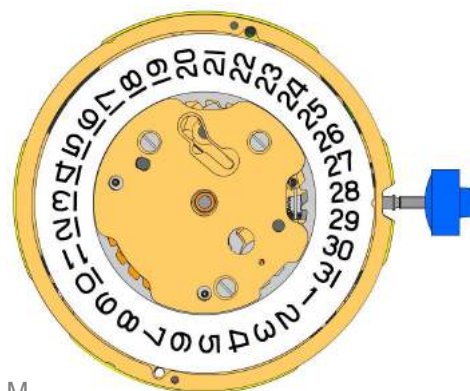

M

3504.208.AB.1.A 71.		Indicateur de quantité (standard) Marquage de l'indicateur à 3 heures.
2130.141 72.		Plaque de maintien de l'indicateur de quantité Plaque maintien indicateur de quantité tenue par 1 vis 4000.250.
3905.070 73.		Ressort sautoir de quantité Insertion du ressort sautoir de quantité dans l'ouverture.
2130.140.G 74.		Plaque de maintien du mécanisme de quantité Plaque maintien mécanisme de quantité tenue par 2 vis 4000.250.
4000.250 75.		Vis
3506.072.G 76.		Support de cadran
8200 77.		Moebius 8200
9014 78.		Moebius 9014
124 79.		Jismaa 124
9020 80.		Moebius 9020

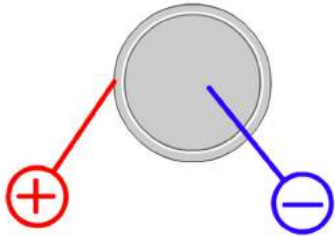

Pile	395
Tension	1.55 V

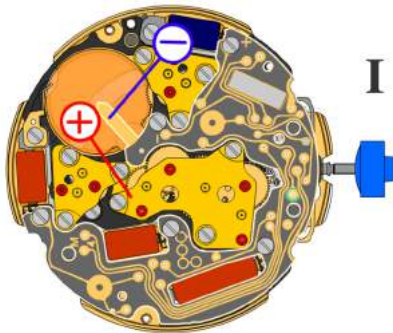

Tige de mise à l'heure en position I, calendrier hors engrenage, intervalle de mesure 60 s pour la marche et la consommation:

Consommation typique	1.48 μA
Consommation maximale	1.65 μA
Marche	-10s/M. .. +20s/M.
Limite inférieure de la tension de fonctionnement	1.20 V

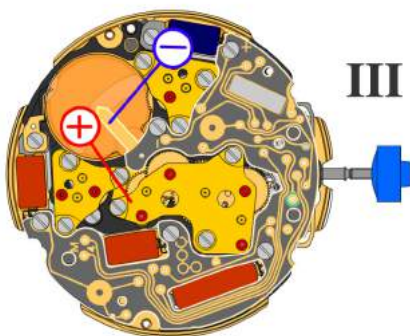

Tige de mise à l'heure en position III, intervalle de mesure 60 s:

Typical consumption	0.10 μA
Maximal consumption	0.30 μA

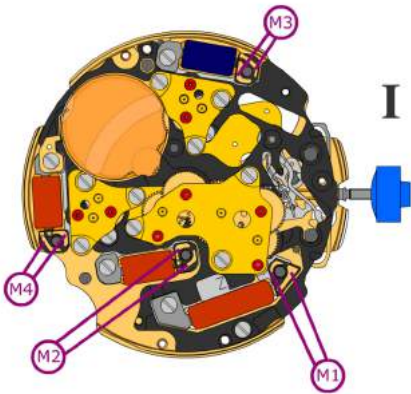

Résistance de la bobine M1 **1.90 k Ω .. 2.10 k Ω**

Résistance de la bobine M2 **1.68 k Ω .. 1.88 k Ω**

Résistance de la bobine M3 **1.68 k Ω .. 1.88 k Ω**

Résistance de la bobine M4 **1.68 k Ω .. 1.88 k Ω**

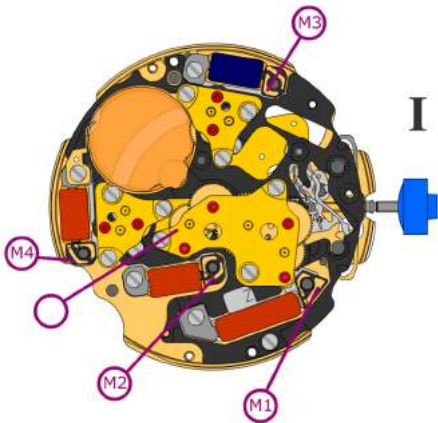

Isolation de la bobine
M1/M2/M3/M4 **∞ k Ω**

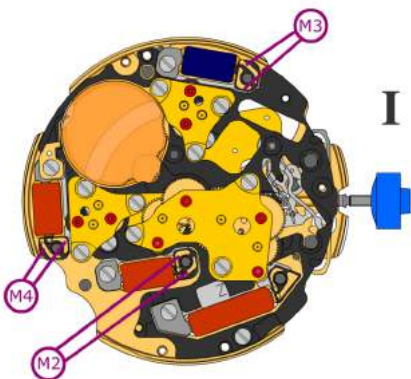

Générateur d'impulsion
(4.9 ms, 8 Hz):



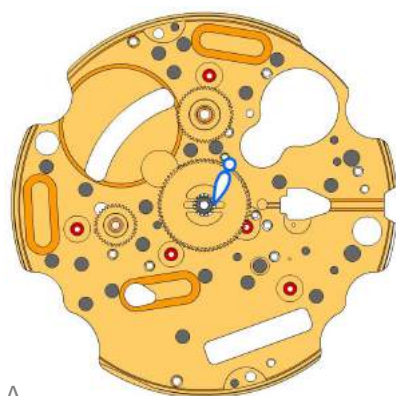



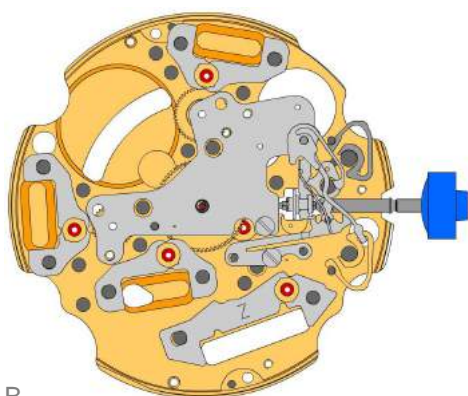











Limite inférieure de la tension de
fonctionnement M2/M3/M4 **1.20 V**







A



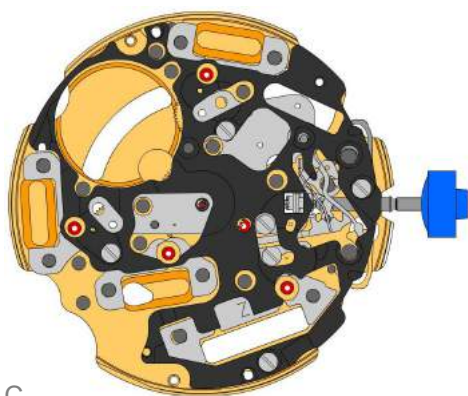



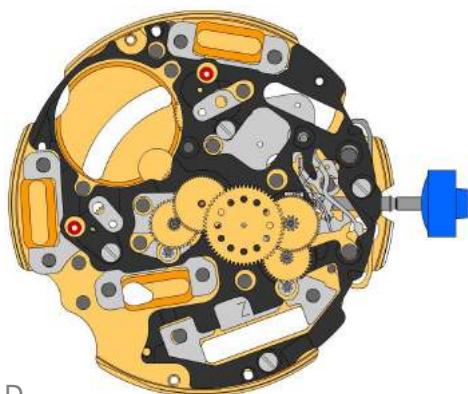

B

2000.574.G 1.		Main plate
3305.282.CO 2.		Cannon pinion with driver (Aig.2)
3301.243 3.		Hour wheel (counter 12h) (Alarm)
3301.244 4.		Hour wheel (counter 24h) (Chrono)
2030.017.CO 5.		Centre bridge Centre bridge held by 1 screw 4000.250.
4000.250 6.		Screw
3001.055.FI 7.		Sliding pinion
3000.177.CO 8.		Setting stem
3017.049 9.		Setting lever
3905.049 10.		Setting lever jumper (3 positions) Setting lever jumper held by 1 screw 4000.250.
4000.250 11.		Screw
3015.081 12.		Yoke (3 positions)
3905.067 13.		Yoke spring Tensioning the spring arm.
3406.030 14.		Pusher jumper B Put the grey jumper between the two posts on the further side.
3406.038 15.		Pusher jumper A Put the yellow jumper between the two posts on the closer side.
3622.040 16.		Stator Mark [Z] on stator.
3622.039 17.		Stator (counter 6h, 9h, chrono)
3622.039 18.		Stator (counter 6h, 9h, chrono)
3622.039 19.		Stator (counter 6h, 9h, chrono)





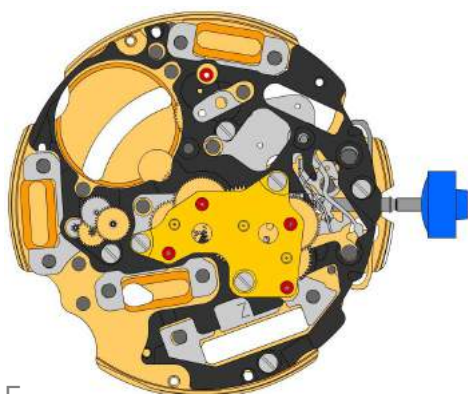

C

3603.079 20.		Plastic bracket Plastic bracket held by 4 screws 4000.250.
4000.250 21.		Screw
3715.094.RK 22.		Rotor
3715.094.RK 23.		Rotor

D

3147.046.CO 24.		Intermediate wheel
3136.142.CO 25.		Second wheel (long)
3147.047.CO 26.		Intermediate wheel (chrono)
3136.144.CO 27.		Chronograph wheel (Aig.2)
3122.056.CO 28.		Third wheel

E



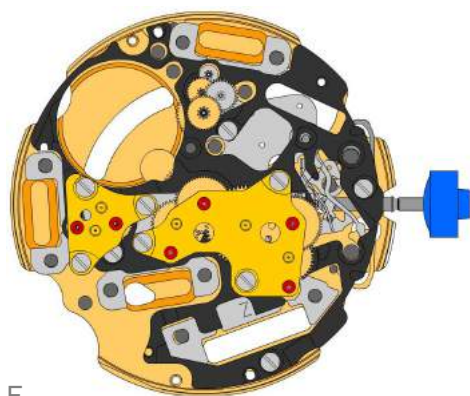

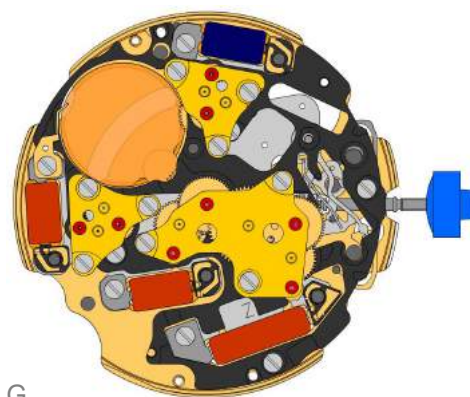

2020.148.G 29.		Train wheel bridge Train wheel bridge held by 3 screws 4000.250.
4000.250 30.		Screw
3715.095.RK 31.		Rotor
3147.048.CO 32.		Intermediate wheel (counter)
3007.056.CO 33.		Minute wheel (counter 24h)
3402.008.CO 34.		Minute counting wheel









F









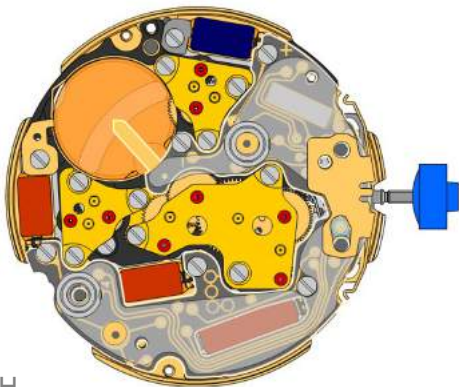
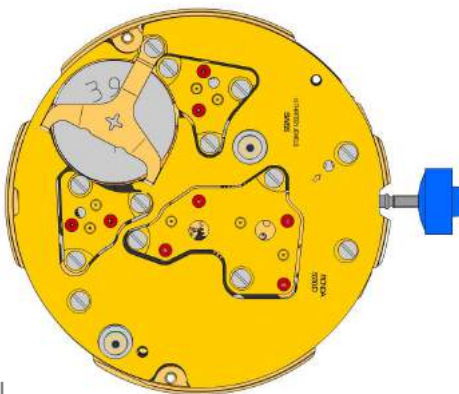





G

2020.149.G 35.		Counter train wheel bridge Counter train wheel bridge held by 3 screws 4000.250.
4000.250 36.		Screw
3715.095.RK 37.		Rotor
3147.048.CO 38.		Intermediate wheel (counter)
3007.055.CO 39.		Minute wheel (counter 12h)
3402.007.CO 40.		Minute counting wheel
4000.250 41.		Screw





2020.149.G 42.		Counter train wheel bridge Counter train wheel bridge held by 3 screws 4000.250.
4000.250 43.		Screw
3621.053.RK 44.		Coil Attention: Please hold the coil only on the grey coil core. Coil held by 1 screw 4000.250.
3621.054.RK 45.		Coil (counter 9h, chrono) Attention: Please hold the coil only on the grey coil core. Coil held by 1 screw 4000.250.
3621.054.RK 46.		Coil (counter 9h, chrono) Attention: Please hold the coil only on the grey coil core. Coil held by 1 screw 4000.250.
3621.055.RK 47.		Coil (counter 6h) Attention: Please hold the coil only on the grey coil core. Coil held by 1 screw 4000.250.
4000.250 48.		Screw

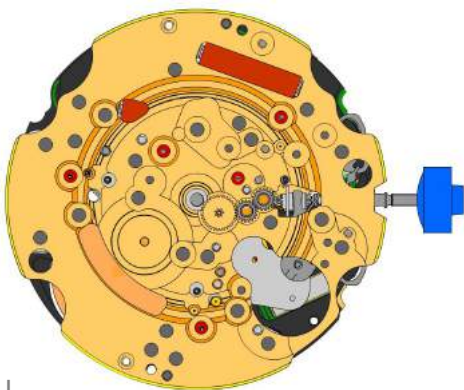

H

I

3601.118 49.		Contact strip Contact strip held by 1 screw 4000.250.
3603.034 50.		Battery insulator
3612.176.5130 51.		Electronic module Electronic module held by 5 screws 4000.250. Electronic measurements may be realised now.
4000.248 52.		Screw
3603.069 53.		Circuit insulator
3603.070 54.		Contact insulator
3603.070 55.		Contact insulator
3601.107.G 56.		Pusher contact spring
2130.159.G.M01.5130D 57.		Electronic module cover Electronic module cover held by 3 screws 4000.250.
3600.010.HGF 58.		Battery 395
3601.109.G 59.		Bridle + Bridle held by 1 screw 4000.250.
4000.250 60.		Screw



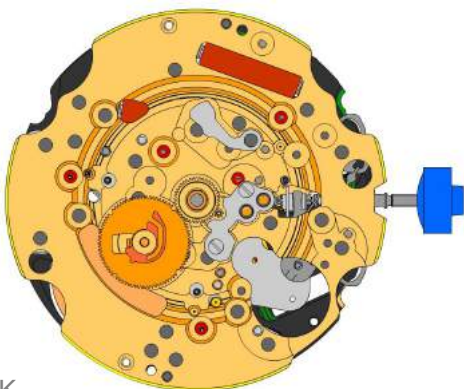





J

2000.574.G 61.		Main plate
3004.164 62.		Setting wheel
3004.164 63.		Setting wheel
3007.054.CO 64.		Minute wheel



K



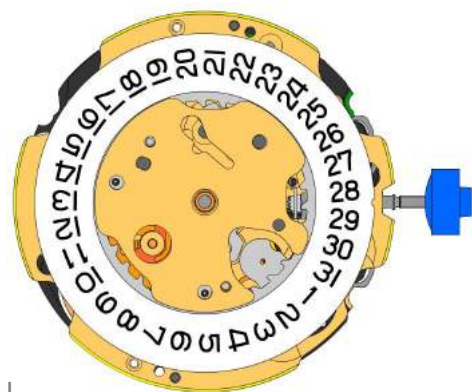



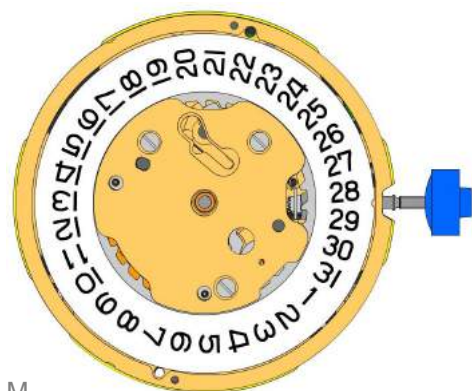



2130.143 65.		Minute train bridge Minute train bridge held by 2 screws 4000.250.
4000.305 66.		Screw
3301.242 67.		Hour wheel (Aig.2)
3315.016 68.		Friction spring
3004.224.CO 69.		Date indicator driving wheel
3500.049 70.		Date jumper



L



M

3504.208.AB.1.A 71.		Date indicator (standard) Nick of the indicator at 3 o'clock.
2130.141 72.		Date indicator maintaining plate Date indicator maintaining plate held by 1 screw 4000.250.
3905.070 73.		Date jumper spring Insert the date jumper spring in the provided opening.
2130.140.G 74.		Date mechanism maintaining plate Date mechanism maintaining plate held by 2 screws 4000.250.
4000.250 75.		Screw
3506.072.G 76.		Dial support
8200 77.		Moebius 8200
9014 78.		Moebius 9014
124 79.		Jismaa 124
9020 80.		Moebius 9020

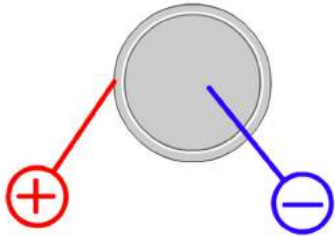

Battery	395
Voltage	1.55 V

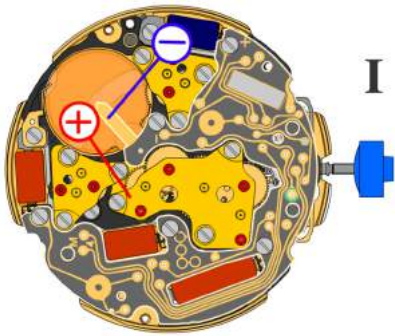

*Setting stem in position I, calendar not in gear,
60 s measuring interval for rate and consumption:*

Typical consumption	1.48 μA
Maximal consumption	1.65 μA
Rate	-10s/M. .. +20s/M.
Lower working voltage limit	1.20 V

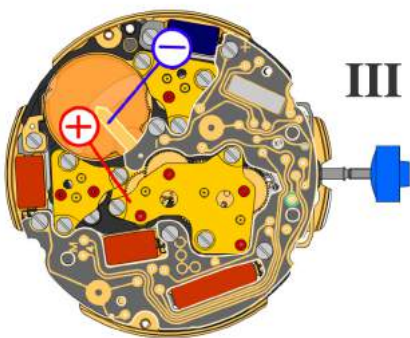

Setting stem in position III, 60 s measuring interval:

Typical consumption	0.10 μA
Maximal consumption	0.30 μA

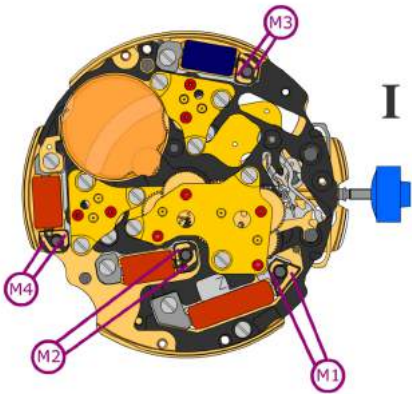

Coil resistance M1 **1.90 kΩ .. 2.20 kΩ**

Coil resistance M2 **1.68 kΩ .. 1.88 kΩ**

Coil resistance M3 **1.68 kΩ .. 1.88 kΩ**

Coil resistance M4 **1.68 kΩ .. 1.88 kΩ**

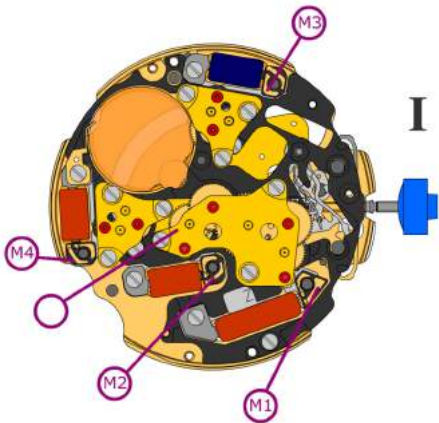

Coil isolation M1/M2/M3/M4 **∞ kΩ**

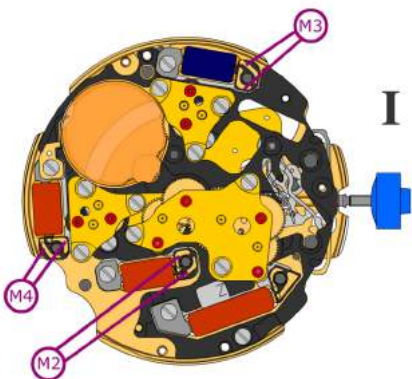

Signal generator (4.9 ms, 8 Hz):

Lower working voltage limit
M2/M3/M4 **1.20 V**

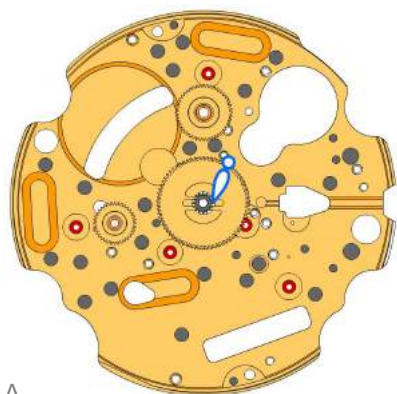



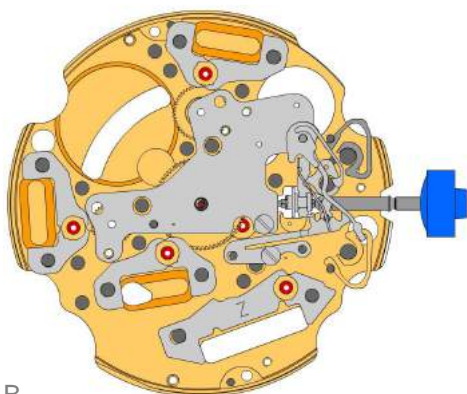









A





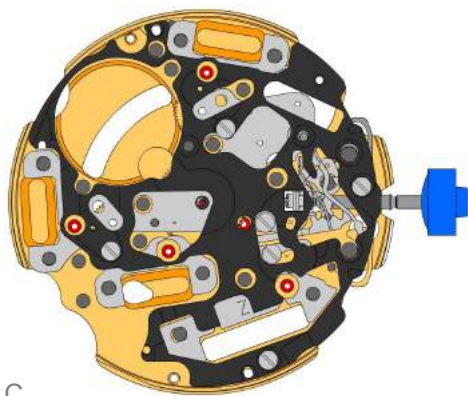

B

2000.574.G 1.		Werkplatte
3305.282.CO 2.		Minutenrohr mit Mitnehmer (Aig.2)
3301.243 3.		Stundenrad (Zähler 12h) (Alarm)
3301.244 4.		Stundenrad (Zähler 24h) (Chrono)

2030.017.CO 5.		Zentrumbrücke Zentrumbrücke gehalten durch 1 Schraube 4000.250.
4000.250 6.		Schraube
3001.055.FI 7.		Kupplungstrieb
3000.177.CO 8.		Stellwelle
3017.049 9.		Winkelhebel
3905.049 10.		Winkelhebelraste (3 Positionen) Winkelhebelraste gehalten durch 1 Schraube 4000.250.
4000.250 11.		Schraube
3015.081 12.		Wippe (3 Positionen)
3905.067 13.		Wippenfeder Den Federarm spannen.
3406.030 14.		Drückerraste B Graue Drückerraste zwischen den beiden Säulen auf der entfernteren Seite platzieren.
3406.038 15.		Drückerraste A Gelbe Drückerraste zwischen den beiden Säulen auf der näheren Seite platzieren.
3622.040 16.		Stator Markierung [Z] auf Stator.
3622.039 17.		Stator (Zähler 6h, 9h, Chrono)
3622.039 18.		Stator (Zähler 6h, 9h, Chrono)
3622.039 19.		Stator (Zähler 6h, 9h, Chrono)





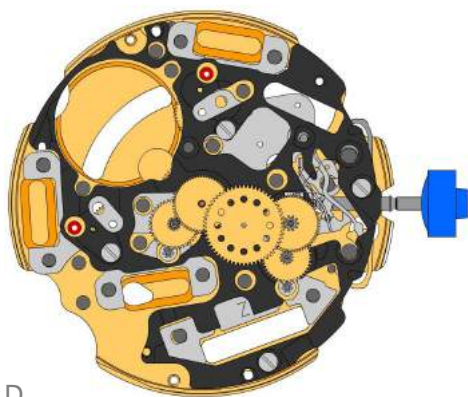

C

3603.079 20.		Kunststoffhalterung Kunststoffhalterung gehalten durch 4 Schrauben 4000.250.
4000.250 21.		Schraube
3715.094.RK 22.		Rotor
3715.094.RK 23.		Rotor



D

3147.046.CO 24.		Zwischenrad
3136.142.CO 25.		Sekundenrad (lang)
3147.047.CO 26.		Zwischenrad (Chrono)
3136.144.CO 27.		Chrono-Zentrumrad (Aig.2)
3122.056.CO 28.		Kleinbodenrad

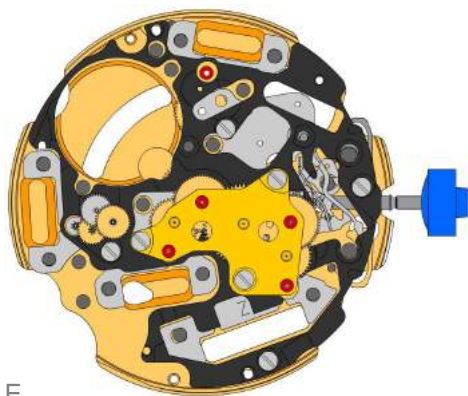

E

2020.148.G 29.		Räderwerkbrücke Räderwerkbrücke gehalten durch 3 Schrauben 4000.250.
4000.250 30.		Schraube
3715.095.RK 31.		Rotor
3147.048.CO 32.		Zwischenrad (Zähler)
3007.056.CO 33.		Wechselrad (Zähler 24h)
3402.008.CO 34.		Minutenzählrad

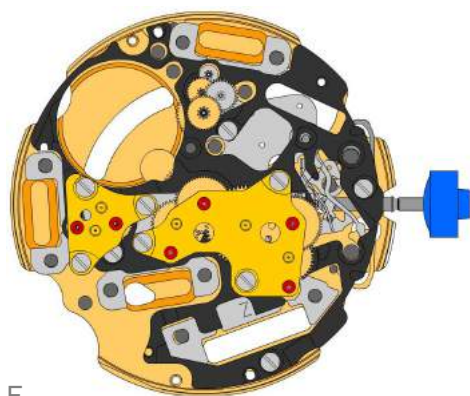

F

2020.149.G
35.  **Zähler-Räderwerkbrücke**
Zähler-Räderwerkbrücke gehalten durch 3 Schrauben 4000.250.

4000.250
36.  **Schraube**

3715.095.RK
37.  **Rotor**

3147.048.CO
38.  **Zwischenrad (Zähler)**

3007.055.CO
39.  **Wechselrad (Zähler 12h)**

3402.007.CO
40.  **Minutenzählrad**

4000.250
41.  **Schraube**

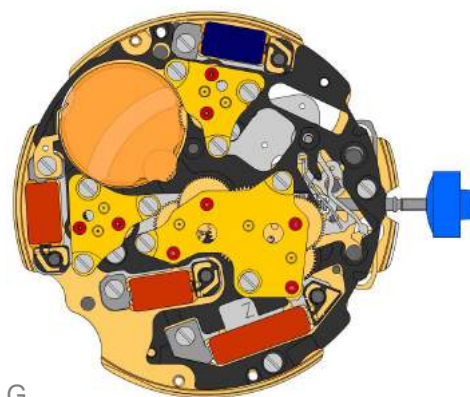

G

2020.149.G
42.  **Zähler-Räderwerkbrücke**
Zähler-Räderwerkbrücke gehalten durch 3 Schrauben 4000.250.

4000.250
43.  **Schraube**

3621.053.RK
44.  **Spule**
Achtung: Spule nur am grauen Spulenkern halten. Spule gehalten durch 1 Schraube 4000.250.

3621.054.RK
45.  **Spule (Zähler 9h, Chrono)**
Achtung: Spule nur am grauen Spulenkern halten. Spule gehalten durch 1 Schraube 4000.250.

3621.054.RK
46.  **Spule (Zähler 9h, Chrono)**
Achtung: Spule nur am grauen Spulenkern halten. Spule gehalten durch 1 Schraube 4000.250.

3621.055.RK
47.  **Spule (Zähler 6h)**
Achtung: Spule nur am grauen Spulenkern halten. Spule gehalten durch 1 Schraube 4000.250.



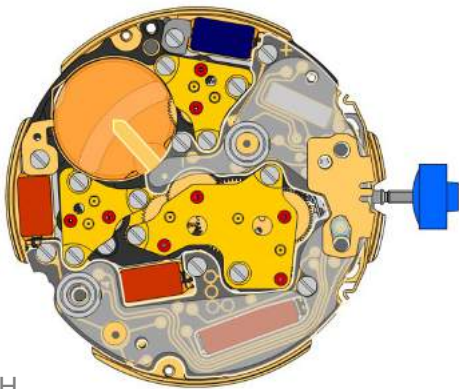



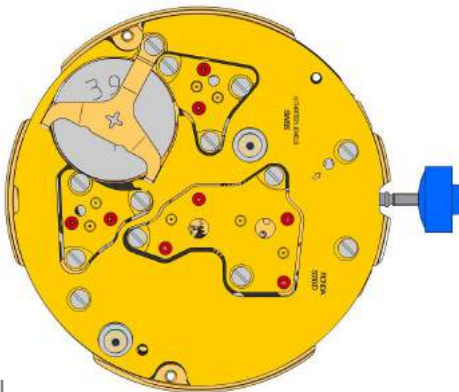





4000.250
48.  **Schraube**



H



I

3601.118 49.		Kontaktbügel Kontaktbügel gehalten durch 1 Schraube 4000.250.
3603.034 50.		Isolation für Batterie
3612.176.5130 51.		Elektronikmodul Elektronikmodul gehalten durch 5 Schrauben 4000.250. Elektronische Messungen können nun vorgenommen werden.
4000.248 52.		Schraube
3603.069 53.		Isolation für Schaltung
3603.070 54.		Isolation für Kontakt
3603.070 55.		Isolation für Kontakt
3601.107.G 56.		Drückerkontaktfeder
2130.159.G.M01.5130D 57.		Deckplatte für Elektronikmodul Deckplatte für Elektronikmodul gehalten durch 3 Schrauben 4000.250.
3600.010.HGF 58.		Batterie 395
3601.109.G 59.		Bügel + Bügel gehalten durch 1 Schraube 4000.250.
4000.250 60.		Schraube

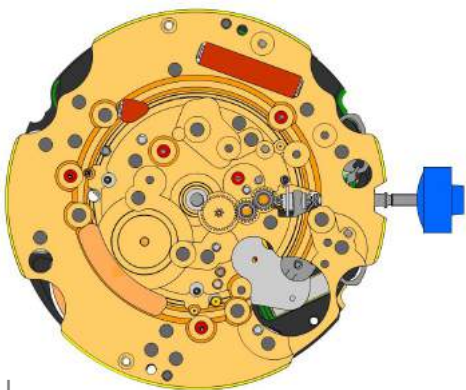

J

 2000.574.G
61.  Werkplatte

 3004.164
62.  Zeigerstellrad

 3004.164
63.  Zeigerstellrad

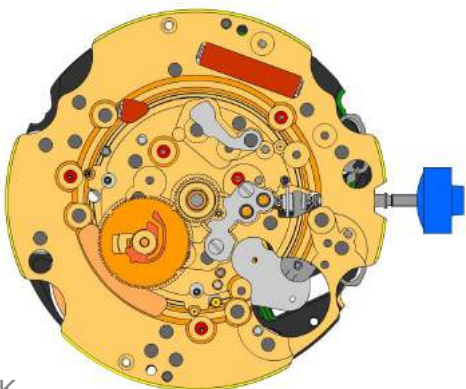
 3007.054.CO
64.  Wechselrad



K

 2130.143
65.  Wechselradbrücke
Wechselradbrücke gehalten durch 2 Schrauben 4000.305.

 4000.305
66.  Schraube

 3301.242
67.  Stundenrad (Aig.2)

 3315.016
68.  Friktionsfeder

 3004.224.CO
69.  Datumanzeiger-Mitnehmerrad



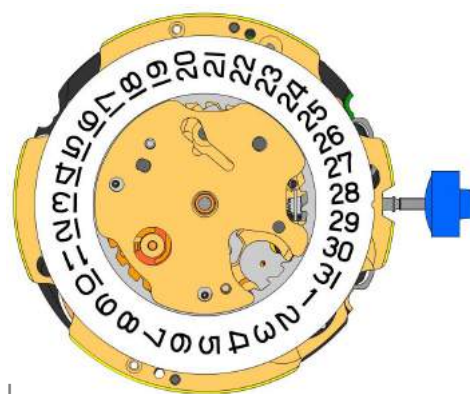



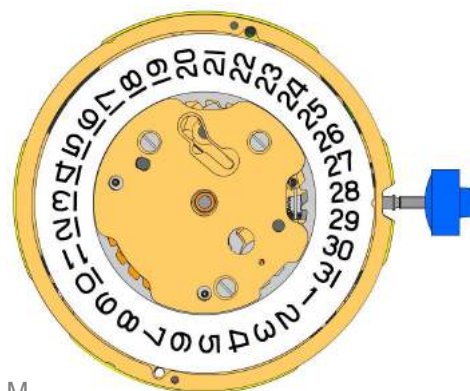



 3500.049
70.  Datumraste



L



M

3504.208.AB.1.A 71.		Datumsanzeiger (Standard) Einbuchtung im Disc bei 3 Uhr.
2130.141 72.		Halteplatte für Datumanzeige Halteplatte für Datumanzeige gehalten durch 1 Schraube 4000.250.
3905.070 73.		Feder für Datumsraste Feder für Datumsraste in die Öffnung einfügen.
2130.140.G 74.		Halteplatte für Datum-Mechanismus Halteplatte für Datum-Mechanismus gehalten durch 2 Schrauben 4000.250.
4000.250 75.		Schraube
3506.072.G 76.		Träger für Zifferblatt
8200 77.		Moebius 8200
9014 78.		Moebius 9014
124 79.		Jismaa 124
9020 80.		Moebius 9020

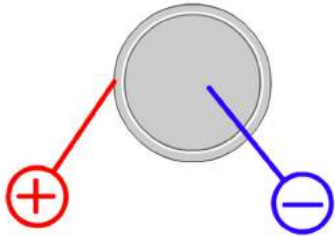

Batterie	395
Spannung	1.55 V

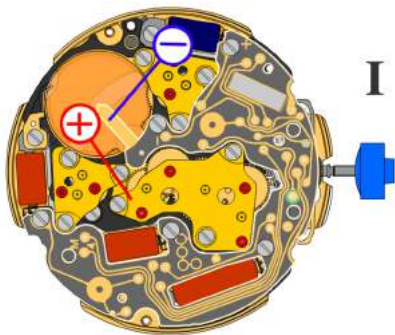

*Stellwelle in Position I, Kalender nicht im Eingriff,
60 s Messintervall für Gang und Verbrauch:*

Typischer Verbrauch	1.48 μA
Maximaler Verbrauch	1.65 μA
Gang	-10s/M. .. +20s/M.
Untere Funktionsspannungsgrenze	1.20 V

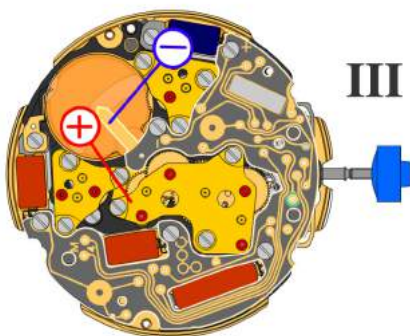

Stellwelle in Position III, 60 s Messintervall:

Typischer Verbrauch	0.10 μA
Maximaler Verbrauch	0.30 μA

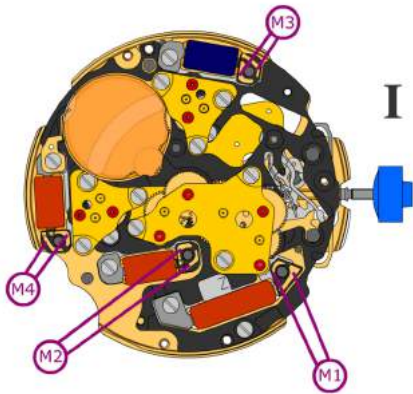

Spulenwiderstand M1 **1.90 k Ω .. 2.10 k Ω**

Spulenwiderstand M2 **1.68 k Ω .. 1.88 k Ω**

Spulenwiderstand M3 **1.68 k Ω .. 1.88 k Ω**

Spulenwiderstand M4 **1.68 k Ω .. 1.88 k Ω**

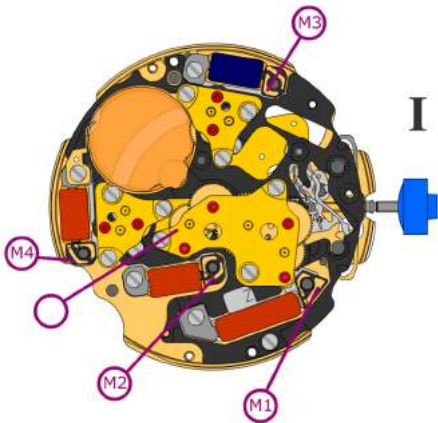

Spulenisolation M1/M2/M3/M4 **∞ k Ω**

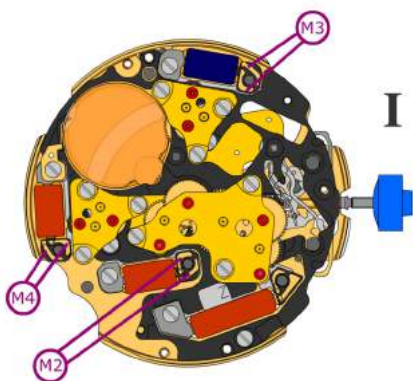

Pulsgenerator (4.9 ms, 8 Hz):

Untere Funktionsspannungsgrenze M2/M3/M4 **1.20 V**