

10 1/2'''

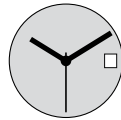

1005

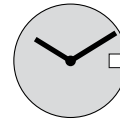

1006

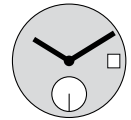

1009



1. Werkdimensionen

1. Dimensions des mouvements

1. Movement dimensions

Kaliber	Ø Total	Ø Werksitz	Werkhöhe	Höhe Batterie	Höhe Stellwelle	Höhe Werkauflage
Calibre	Ø Total	Ø Encageage	Hauteur mouvement	Hauteur pile	Hauteur tige	Hauteur filet
Caliber	Ø Total	Ø Case fitting	Movement height	Height of battery	Height of stem	Movement rest
Einh./ Unité/ Unit	mm	mm	mm	mm	mm	mm
1005-1009	23,90	23,30	1,90	1,90	0,75	0,35
Stellwellengewinde/ Filetage de la tige/ Stem thread: Ø 0,90 mm					Weg/ Chemin/ Length of travel: 1,00 mm	

2. Funktionen

2. Fonctions

2. Functions

Kaliber	Stellwellenpos.	Funktionen
Calibre	Pos. de tige	Fonctions
Caliber	Stem position	Functions
1006	1	Normale Position / Position normale / Running position
	2	Datumkorrektur / Correction de la date / Date correction
	3	Zeiger stellen, mit Unterbruch der Motorimpulse Mise à l'heure, avec interruption des impulsions moteur Hand setting, with interruption of the motor pulses
1005, 1009	1	Normale Position / Position normale / Running position
	2	Datumkorrektur / Correction de la date / Date correction
	3	Zeiger stellen, Sekunden-Stopp mit Unterbruch der Motorimpulse Mise à l'heure, stop-seconde avec interruption des impulsions moteur Hand setting, stop-second with interruption of the motor pulses

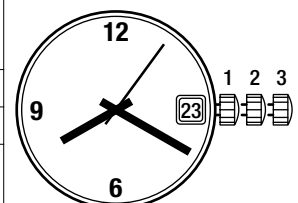

Werkaufbau

Assemblage

Assembling

10¹/₂" 1005, 1006

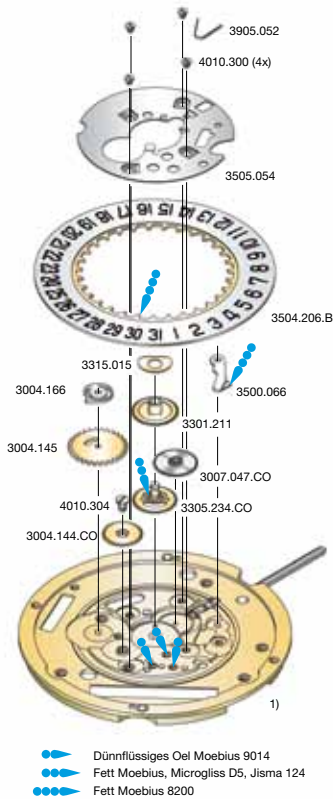
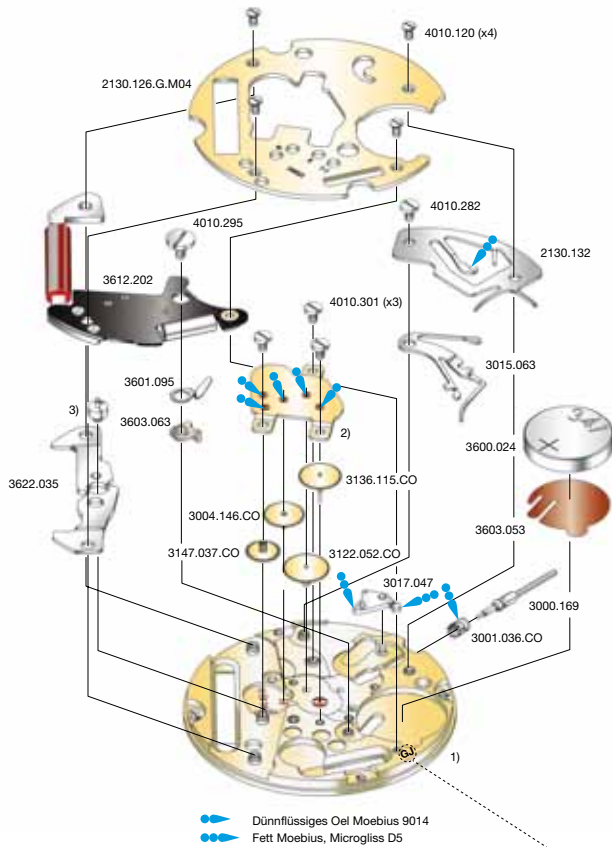

Düninflüssiges Öl Moebius 9014
 Fett Moebius, Microgliss D5

Düninflüssiges Öl Moebius 9014
 Fett Moebius, Microgliss D5, Jisma 124
 Fett Moebius 8200

Code: Beispiel GJ / exemple GJ / exemple GJ

Cal. 1005	Werkseite / Côté mouvement / Movement side		
Plan no.	Bestandteile	Fournitures	Spare Parts
1)	Werkplatte	Platine	Main plate
2)	Räderwerkbrücke	Pont rouage	Train w. bridge
2130.126.G.M04	Modul-Abdeckp.	Couvre module	Module cover pl.
2130.132	Deckplatte	Couvre mec.	Setting lever cov.
3000.169	Stellwelle	Tige	Stern
3001.036.CO	Kupplungstrieb	Pignon coulant	Sliding pinion
3004.146.CO	Sekundenzw.rad	Renvoi seconde	Second driv. wh.
3015.063	Wippe	Bascule	Yoke
3017.047	Winkelhebel	Tirette	Setting lever
3122.052.CO	Kleinbodenrad	Roue moyenne	Third wheel
3136.115.CO	Sekundenrad	Roue secondes	Second-wheel
3147.037.CO	Zwischenrad	Roue interméd.	Intermed. wheel
3600.024	Batterie	Pile	Battery
3601.095	Batterie-Kontakt	Bride contact	Battery contact
3603.053	Batterie-Isolation	Isolateur pile	Battery insulation
3603.063	Kontakt Isolation	Isolateur bride	Batt. contact ins.
3612.202	Modul m. Spule	Module av. bobine	Module w. coil
3622.035	Stator	Stator	Stator
3)	Rotor	Rotor	Rotor
4010.120	Schraube	Vis	Screw
4010.282	Schraube	Vis	Screw
4010.295	Schraube	Vis	Screw
4010.301	Schraube	Vis	Screw

Abweichungen / Divergences / Deviations

Cal. 1006	Werkseite / Côté mouvement / Movement side		
Plan No.	Bestandteile	Fournitures	Spare Parts
1)	Werkplatte	Platine	Main plate
2130.126.G.M01	Modul-Abdeckp.	Couvre module	Module cover pl.
3136.117.CO	Sekundenrad	Roue secondes	Second wheel

	2. Buchstabe: A-J Second letter: A-J 2 ^{ième} chiffre: A-J	2. Buchstabe: ab K Second letter: from K 2 ^{ième} chiffre: à partir de K	Cal. Cal. Cal.
1)	2000.605.G	2000.685.G	1005/1006
2)	2020.141.G.M01	2020.183.G.M01	1005/1006
3)	3715.070.RK	3715.115.RK	1005/1006

Cal. 1005	Zifferblattseite / Côté cadran / Dial side		
Plan no.	Bestandteile	Fournitures	Spare Parts
1)	Werkplatte	Platine	Main plate
3004.144.CO	Zw.rad Kalender	Roue interm. cal.	Cal. interm. wh.
3004.145	Datummitn.-rad	Renvoi entrain.	Ind. driving wh.
3004.166	Datumfinger	Doigt entraineuse	Date finger
3007.047.CO	Wechselrad	Minuterie	Minute wheel
3301.211	Stundenrad	Canon	Hour wheel
3305.234.CO	Minutenrohr	Chaussée	Cannon pinion
3315.015	Spreizfeder	Clinquant	Washer
3500.066	Datumraste	Cliquet calendrier	Date jumper
3504.206.B	Datumanzeiger	Bague	Date indicator
3505.054	Kal.-Abdeckplatte	Couvercle calend.	Date ind. guard
3905.052	Feder Datumraste	Ressort cliquet	Date jumper spr.
4010.300	Schraube	Vis	Screw
4010.304	Schraube	Vis	Screw

Abweichungen / Divergences / Deviations

Cal. 1006	Zifferblattseite / Côté cadran / Dial side		
Plan No.	Bestandteile	Fournitures	Spare Parts
1)	Werkplatte	Platine	Main plate
3305.257.CO	Minutenrohr	Chaussée	Cannon pinion

Batterien / Piles / Batteries

1005-1009	Nr. 341 Dim. Ø x H:	SR 920 SW 7.90 x 1,45
-----------	------------------------	--------------------------

10 1/2''' 1009

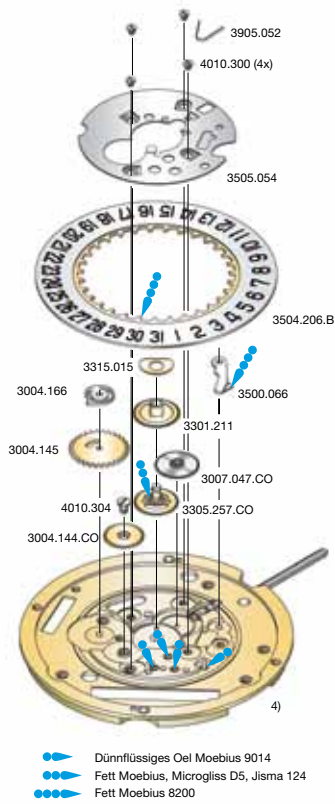
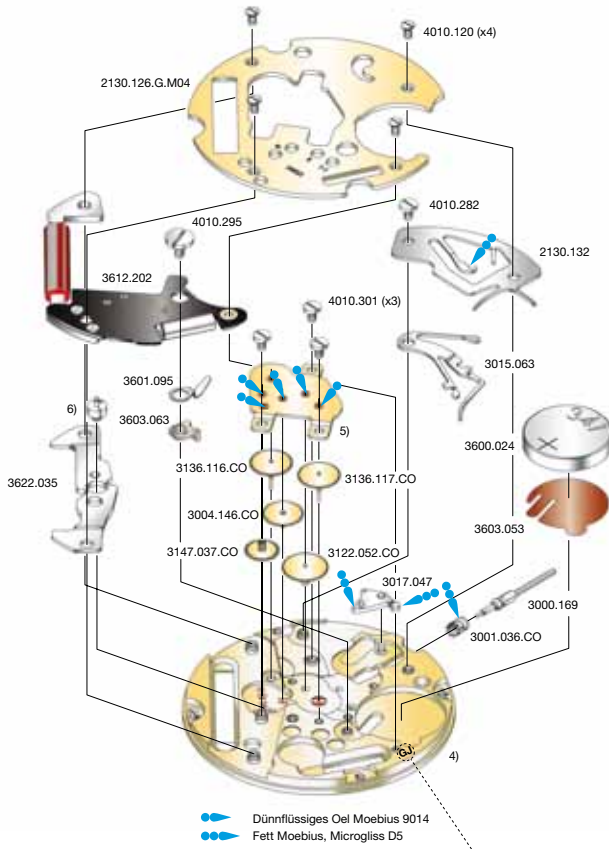

Code: Beispiel GJ / exemple GJ / exemple GJ

Cal. 1009	Werkseite / Côté mouvement / Movement side		
Plan no.	Bestandteile	Fournitures	Spare Parts
4)	Werkplatte	Platine	Main plate
5)	Räderwerkbrücke	Pont rouge	Train w. bridge
2130.126.G.M04	Modul-Abdeckp.	Couvre module	Module cover pl.
2130.132	Deckplatte	Couvre mec.	Setting lever cov.
3000.169	Stellwelle	Tige	Stem
3001.036.CO	Kupplungstrieb	Pignon coulant	Sliding pinion
3004.146.CO	Sekundenzw.rad	Renvoi seconde	Second driv. wh.
3015.063	Wippe	Bascule	Yoke
3017.047	Winkelhebel	Tirette	Setting lever
3122.052.CO	Kleinbodenrad	Roue moyenne	Third wheel
3136.116.CO	Kl. Sek. Radwelle	Roue axe pet. sec.	Sm. sec. w. pivot
3136.117.CO	Sek.-rad kurz	Roue sec. courte	Sec. wheel short
3147.037.CO	Zwischenrad	Roue interméd.	Intermed. wheel
3600.024	Batterie	Pile	Battery
3601.095	Batterie-Kontakt	Bride contact	Battery contact
3603.053	Batterie-Isolation	Isolateur pile	Battery insulation
3603.063	Kontakt Isolation	Isolateur bride	Batt. contact ins.
3612.202	Modul m. Spule	Module av. bobine	Module w. coil
3622.035	Stator	Stator	Stator
6)	Rotor	Rotor	Rotor
4010.120	Schraube	Vis	Screw
4010.282	Schraube	Vis	Screw
4010.295	Schraube	Vis	Screw
4010.301	Schraube	Vis	Screw

	2. Buchstabe: A-J Second letter: A-J 2 ^{ième} chiffre: A-J	2. Buchstabe: ab K Second letter: from K 2 ^{ième} chiffre: à partir de K	Cal. Cal. Cal.
4)	2000.609.G	2000.689.G	1009
5)	2020.142.G.M01	2020.184.G.M01	1009
6)	3715.070.RK	3715.115.RK	1009

Cal. 1009	Zifferblattseite / Côté cadran / Dial side		
Plan no.	Bestandteile	Fournitures	Spare Parts
4)	Werkplatte	Platine	Main plate
3004.144.CO	Zw.rad Kalender	Roue interm. cal.	Cal. interm. wh.
3004.145	Datummitn.-rad	Renvoi entrain.	Ind. driving wh.
3004.166	Datumfinger	Doigt entraineuse	Date finger
3007.047.CO	Wechselrad	Minuterie	Minute wheel
3301.211	Stundenrad	Canon	Hour wheel
3305.257.CO	Minutenrohr	Chaussée	Cannon pinion
3315.015	Spreizfeder	Clinquant	Washer
3500.066	Datumraste	Cliquet calendrier	Date jumper
3504.206.B	Datumanzeiger	Bague	Date indicator
3505.054	Kal.-Abdeckplatte	Couvercle calend.	Date ind. guard
3905.052	Feder Datumraste	Ressort cliquet	Date jumper spr.
4010.300	Schraube	Vis	Screw
4010.304	Schraube	Vis	Screw

3. Leistungen

3. Performances

3. Performances

Kaliber Calibre Caliber	Bedingungen Conditions Conditions	Momentaner Gang Marche instantanée Instantaneous rate	Drehmoment Couple utile Torque	Gangreserve Autonomie Autonomy
	Einheit / Unité / Unit Typ.Wert / Valeur / value	Mi (s/month)	T (µNm) sec. min.	A (Monat/mois/month)
1005-1009	1,55 V 23°C Batt./ Pile 13,5 mAh	- 10/+ 20	4 200	24
Magnetfeldabschirmung / Résist. aux champs magn. / Resist. to magnetic fields			18,8 Oe 1500 A/M	
Betriebstemperatur / Température d'opération / Operating temperature			0-50°C	
Schockresistenz / Résistance au choc/ Shock resistance			NIHS 91-10	

Anzeige Ende der Batterielaufzeit EOL

Der Sekundenzeiger hält während 4 Sekunden an und holt dann die 4 Sprünge kurzfristig nach.

Indication de fin de vie de pile

L'aiguille de seconde s'arrête durant 4 secondes puis fait rapidement 4 pas.

Battery end-of-life indication EOL

The second hand stops for 4 seconds before executing rapidly the 4 steps.

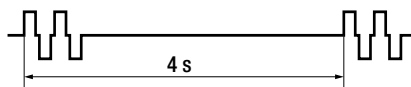

Folgende Kaliber sind mit dem EOL-System ausgerüstet:

Les calibres suivants sont munis du système EOL:

The following calibers are equipped with EOL:

Swiss Made 10¹/₂"^{'''} – 1005, 1009

4. Elektr. Messungen

4. Contrôles électriques

4. Electrical checking

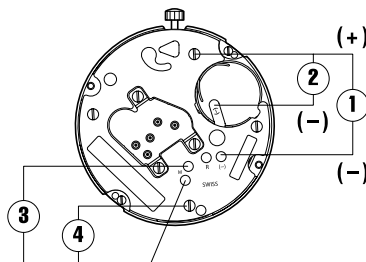

Kaliber Calibre Caliber	Pos. Pos. Pos.	Einheit Unité Unit	Messwerte Valeurs mesurées Measured values	Kontrolle Contrôle Check	Bemerkungen Remarques Remarks
1005-1009	1	V	1,55	Batterie-Spannung Tension de la pile Battery voltage	Mit Batterie Avec pile With battery
1005-1009	2	µA	0,50-0,95	Stromaufnahme Consommation de courant Current consumption	Ohne Batterie, mit externer Speisung Sans pile, avec alimentation externe Without battery, with external supply
1005-1009	2	V	< 1,30	Funktionskontrolle bei Minimalspannung Contrôle de fonctionnement à tension minimale Check with lowest possible voltage	Ohne Batterie, mit externer Speisung Sans pile, avec alimentation externe Without battery, with external power supply
1005-1009	3	KΩ	2,50-2,70	Spulenwiderstand Résistance de la bobine Resistance of the coil	Ohne Batterie Sans pile Without battery
1005-1009	4	KΩ	∞	Spulenisolation Isolation de la bobine Coil insulation	Ohne Batterie Sans pile Without battery
1005-1009		Sek./Monat sec./mois sec./month	- 10/+ 20	Induktivsonde 60 Sek. Senseur inductif 60 sec. Inductive sensor 60 sec.	Mit Batterie Avec pile With battery

5. Zeigerwerk

5. Aiguillage

5. Dial-train

Kaliber Calibre Caliber	Zeigerwerk Aiguillage Height of dial train	Einzelteil-Höhe Hauteur de la pièce ind. Height of individ. piece				Höhe ab Zifferblattauflage Dépassement platine Height from base			Ø Zeigeranpassung Ø Ajust. des aiguilles Ø Adjustm. of hands			Zifferblattstärke Epaisseur du cadran
		mm	mm	mm	mm	mm	mm	mm	mm	mm	mm	mm
	No.	A	B	C	D	E	F	G	H	I	K	
1005	0	1,62	0,80	3,12	1,15	0,96	0,60	1,25	1,20	0,70	0,20	0,30
	1	1,82	1,00	3,42	1,42	1,10	0,80	1,55	1,20	0,70	0,20	0,40
1006	0	1,65	0,80	–	1,14	0,93	0,60	–	1,20	0,70	–	0,30
	1	1,85	1,00	–	1,25	1,13	0,80	–	1,20	0,70	–	0,40
1009	1	1,85	1,00	2,37	1,25	1,13	0,80	0,45	1,20	0,70	0,20	0,40

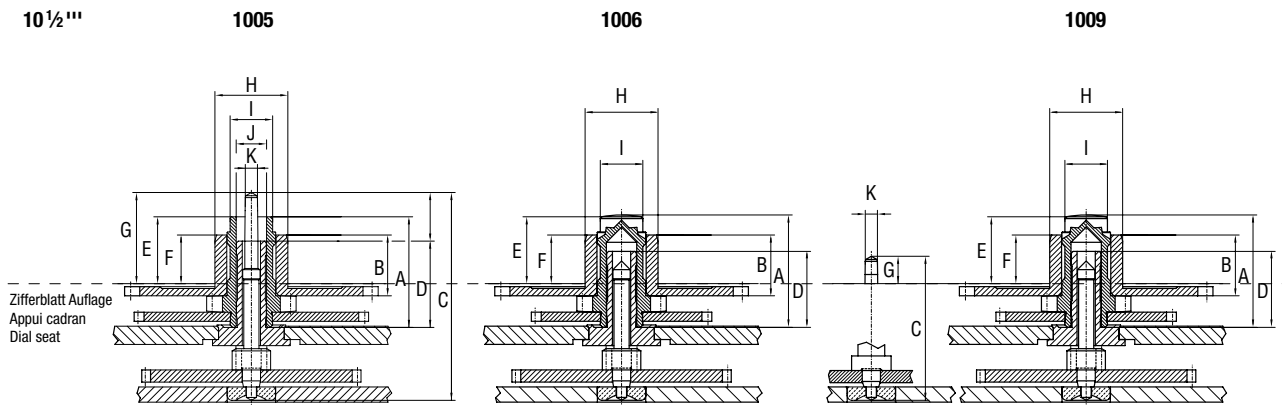

Für Einzelheiten verlangen Sie bitte die entsprechenden Zeigerwerkpläne!
 Pour plus de détails demandez nos plans d'aiguillage!
 For more detailed information please ask for the corresponding hand drawings!

6. Einschalen/Werkzeuge

6. Emboîtement/outils

6. Casing/tools

Nr. H 100x.1A



Nr. H 100x.1T



SWISS MADE	
2 Schrauben 2 Vis 2 Screws	

Zeigersetzen

Maximale Aufpresskraft:

- Stunden und Minutenzeiger: max. 40N
- Sekundenzeiger: max. 30N

Beim Zeigersetzen muss das Werk abgestützt werden.

Poser les aiguilles

Force de chassage maximale:

- Aiguilles des heure et des minutes: max. 40N
- Aiguille des secondes: max. 30N

Lors de la pose d'aiguilles, le mouvement doit être soutenu.

Hand setting

Maximal force:

- Hour and minute hands: max. 40N
- Second hand: max. 30N

The movement needs to be supported for hand setting.

Stellwelle entfernen

Beim Entfernen der Stellwelle muss sich die Stellwelle in Position 1 (gedrückt) befinden, bevor auf den Winkelhebel gedrückt wird.

Enlever la tige

En enlevant la tige, la tige doit se trouver en position 1 (poussée), avant de pousser sur la tirette.

Stem removal

For removal of the stem, the stem must be pushed into position 1 (pressed in) prior to apply pressure to the setting lever.

10 1/2''' 1005, 1006

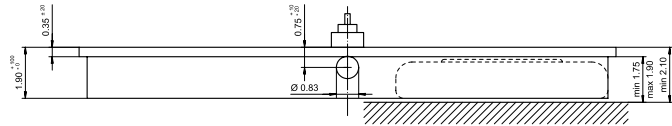

Seite Gehäuseboden
Côté fond de boîte
Case back side

Zifferblattseite
Côte cadran
Dial side

Zifferblattfüße
Pieds de cadran
Dial feet

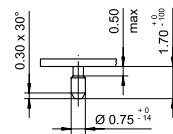
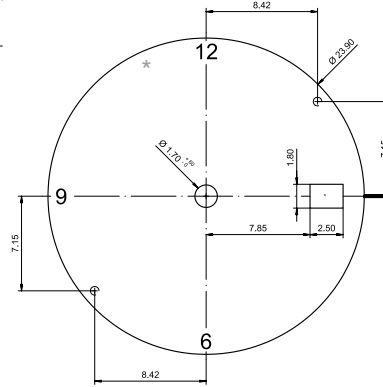
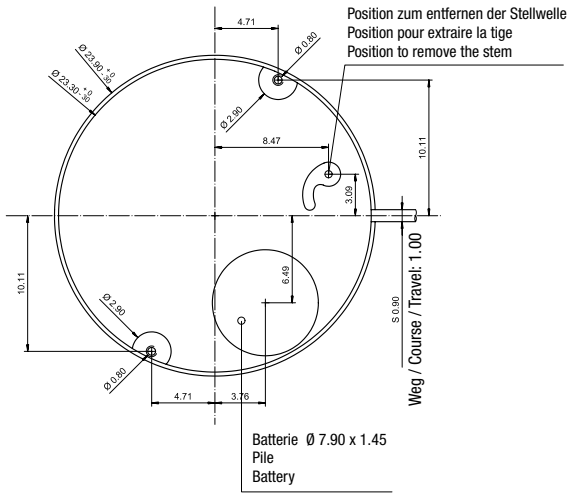

10 1/2''' 1009

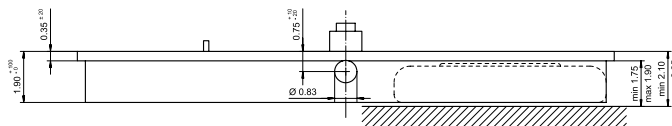

Seite Gehäuseboden
Côté fond de boîte
Case back side

Zifferblattseite
Côte cadran
Dial side

Zifferblattfüße
Pieds de cadran
Dial feet

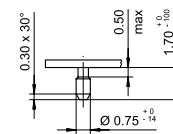
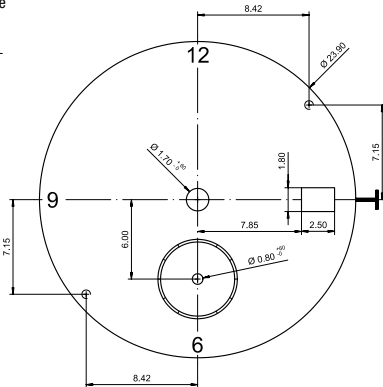
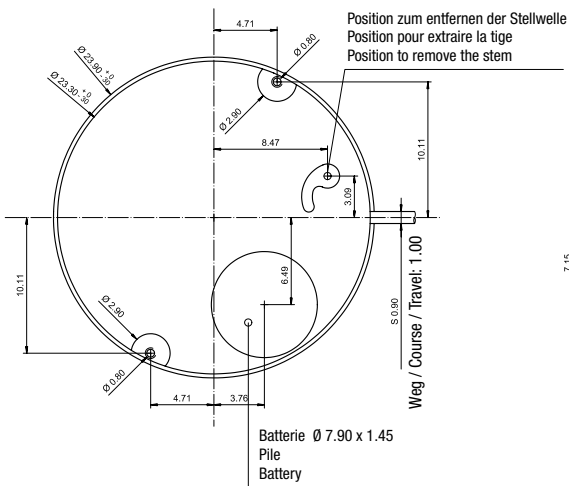

Vis No.:
Schraube Nr.: 4000.236
Screw No.:

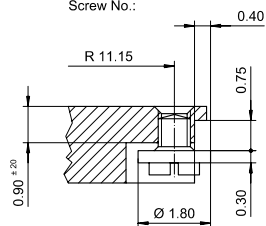

Vis No.:
Schraube Nr.: 4000.237
Screw No.:

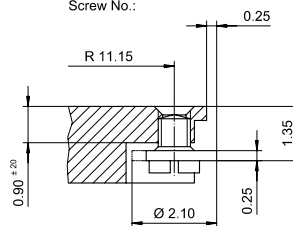

Sicherheit zwischen Minutenzeiger und Glas min. 0,30 mm
Sécurité entre l'aiguille des minutes et le verre min. 0,30 mm
Security between minute hand and glass min. 0,30 mm

Das Zifferblatt muss durch die Schale gehalten werden.
Le cadran doit être tenu par la boîte.
The dial must be hold by the case.